

H

A

I

N

E

S

Quality

12-Volt Mobile Electronics Since 1971 Installation Hardware and Accessories



MOBILE ELECTRONICS

Haines Enterprises Inc.
85D South Hoffman Lane - Islandia, New York 11749

Toll Free: 800-634-2958

Local: 631-348-1750 - Fax: 631-348-1770

www.hainesmobil.com

www.hainesenterprises.com

EMAIL: info@hainesenterprises.com

TERMS AND CONDITIONS

To Order Call:

(800) 634-2958

(631) 348-1750

or FAX (631) 348-1770

Email: Sales@Hainesenterprises.com

WWW.HAINESENTERPRISES.COM

Hours

Monday-Friday

9:00AM – 5:00 PM EST.

Please have part numbers and quantities ready before you call.

Terms

All orders that are COD Check - must have prior approval for company check, unless customer has been approved for credit terms. There is a \$50.00 minimum on all orders. MasterCard, Visa, American Express and Discover are also accepted. By using a credit card you save the UPS COD charge. No COD CASH orders.

Shipping Options

UPS, Federal Express, Common Carrier and Air Freight

Back Orders

While we stock a large inventory of our products, occasionally back orders do occur. We hold back orders for 30 days. Back orders for less than \$15.00 will be cancelled and not be shipped unless reordered. Any COD charges on backordered products will be paid by Haines.

100% Satisfaction Guarantee

Damaged Goods

You own all goods once shipped. Therefore, we recommend you inspect all shipments upon their arrival. Note all damage and notify the carrier. Although we cannot make a claim for you, if goods were damaged in transit, we will offer as much assistance as possible.

Returns

No merchandise will be accepted without prior authorization. If merchandise is returned for any reason other than defective, a 15% restocking fee will be charged. Any merchandise returned for any reason other than defective must be returned within 30 days from the invoice date and be in resalable condition.

Discontinued merchandise will not be accepted for return. **NO REFUNDS CREDIT ONLY**

Warranty

All products carry a 30 day warranty from the original shipping date.

If the product is abused, misused, mistreated, modified or ill treated in any other way the warranty is void.

Limitation of Liability

Haines liability for any claim shall not exceed the purchase price of the goods. Haines shall not be liable for special or consequential damages, including but not limited to loss of profits, loss of use of goods or any associated goods, or cost of substitute goods. This limitation applies whether such claim arises from warranty or negligence and whether such claim arises from design, manufacture or sale.



INDEX



PRODUCT	PAGE
3M PRODUCTS	
3M Hook & Loop	28
3M Scotchkote Sealer	29
3M Shrink Tubing	29
3M Silicone Lubricant	29
3M Splicing Compound	29
3M Super Adhesive	29
3M Tape	28 & 29
3M Terminals	26 & 27
A	
ABS Plastic Sheets	99
Actuators	111
Alarms	50 thru. 56 & 85 thru. 89
Alligator Clips	19
Amp Wiring Kits	84,77 & 98
Antenna Adapters	104
Antenna Extensions	104
Antenna Power	104

PRODUCT	PAGE
B	
Back Straps	44
Back-up Sirens	111
Banana Plugs	45
Batteries	46 & 111
Battery Clips	19
Battery Post Extenders	108
Battery Terminals	108
Beeper	110
Bojo Hand Tools	32
Blade Fuse ATY & ATYM	40
Bosch Relays	110
Bluefusion	117
Bullet Terminals	9
Butt Splices	10 & 27
Butyl Rubber	30



INDEX



PRODUCT	PAGE
C	
Cable Clamps	22
Cable Ties	
Heavy Duty	23
Mounting Hole	23
Releasable	23
Standard	23
Tools	22
Cameras	51 & 52
Camouflage Screw Caps	44
Capacitors	100
Carpet	47 & 48
Cellular In-Dash Mounts	113
Cellular Mounts	114 thru. 115
Chemicals	30
Choke Suppressor	102
Cigarette Lighter Adapters	116
Circuit Breakers	43
Circuit Testers	37
Converters	101
Copper Terminals	18
Crimestopper	49 thru. 56
Crimp Tool	32 & 34
Crimp Caps	11
D	
Diodes	110
Distribution Blocks	66,74,75,77,81,107 & 108
Door Lock Actuators	111
Door Panel Fasteners	13 Thru 17
Door Pops	111
Double Sided Tape	28 & 31
Drill Bits	35
Drop Light	38 & 39
Duct Tape	28

PRODUCT	PAGE
E	
Electrical Tape	28 & 31
F	
Fans	99
Flanged Spade Terminal	7
Female Quick Disconnect	8
Flashers	110
Flex Mounts	115
FM Modulators	61
Fuse Block Extension	41
Fuse Holders	41,42 & 43
Fuse Panels	41
Fuse Puller	37
Fuse Taps	43
Fuses	40, 42 & 43
G	
Glass Fuse	42
Glue	30
Glue Gun	31
Glue Sticks	31
Gold Battery Terminal	108
Gold Distribution Blocks	108
Gold Fuse Holder	107
Gold Terminals	107
Grill Cloth	48
Grommets	20
H	
Harness	58
Headlight Bulbs and H.I.D. Kits	105 & 106
Heat Shrink Tubing	28
Hook & Loop	28 & 31



INDEX



PRODUCT	PAGE
I	
Ignition Tool	32
Ipod Accessories	90, 117, 118 & 120
J	
K	
Kits	
Resistor	110
Terminal	12
Smart Fix Kits	13 Thru 17
Klein Tools	34, 35
L	
LED'S	111
Lighting	39, 105 & 106
Line Out Converter	101
Lisle Tools	36 & 37
Loom	23
Loom Tools	23
M	
Magnetic Pick Up Tool	36
Metra	103
Mounting Pads	22
N	
Noise Filters	102
P	
Panavise	113 Thru 115
Pedestal Mounts	115
Piggy Back Terminal	10
Pin Switch	109
Pin Switch Bracket	109
Power Antenna	104
Power Wire & Cable	25
Primary Wire	24
Pulse Stretcher	101

PRODUCT	PAGE
Q	
Quick Splice	11
Quick Disconnect Female and Male	8 & 9
R	
Ratchet Crimp Tool	32
Razor Blade Scraper	36
Razor Blades	32
RCA Barrels	45
RCA Cables	45
RCA, "Y" Cables	45
RCA, Right Angle Plugs	45
Relays and Harness	110
Remote Starts	54
Renegade Products	91 Thru 98
Ring Terminals	5 & 6
Resistors and Resistor Kits	110
S	
Scosche Products	57 thru 83
Screw Driver Bits	35
Screws	21
Screw Caps	44
Shop Light	39
Siren Backup	111
Sliding Door Contact	109
Solder	31
Sound Dampening	120
Solder Torches	33
Soldering Iron	31
Spade Terminal	7
Speaker Boxes	83,94,95 & 99
Speaker Wire	25
Speakers	70,71,95,96 & 97
Splicing Compound	29
Split Loom	23
Spray Glues	29 & 30



INDEX



PRODUCT	PAGE
S	
Storage Box Racks	37
Subwoofers	70 & 95
Switches	44 & 110
T	
Tap Caps	44
Tape	
Double Stick Mounting Tape	28 & 31
Duct	29
Electrical	28 & 31
Masking	28
Terminal Cups	99
Terminal Kits	12
Terminals	
3M Terminals	26 & 27
Butt Splice	10
Bullet	9
Female Quick Disconnect	8
Heat Shrink	5 Thru 10
Male Quick Disconnect	9
Piggy Back	10
Quick Splice	11
Rings	5 & 6
Spade	7
T-Taps	11
Tools	
BOJO Interior Installation tools	32
Crimp tool	18 & 32
Ignition	32
Klein	34 & 35
Lisle	36 & 37
Razor Blades	32
Soldering Iron	31
Soldering Torch	33
Wire Stripper	32

PRODUCT	PAGE
T	
Transponder	55,89 & 90
Trunk Liner	48
Trunk Release	111
U	
Unibit	35
Utility Blades	32 & 35
Universal Mounting Bracket	112
V	
Valet Switch	44
Velcro	31
Video Mounts	115
Vinyl Sheets	48
W	
Washers	20
Window Roll Up Module	111
Wire	
Power	25
Primary	24
Scosche	25
Zip Cord	25
Wire Nuts	11
Wire Rack	38
Wire Ties	23
Woofers Grill & Hardware	99
Work Light	23
Wire Loom	23
Wire Loom Tools	23



RING TERMINALS

MANY OF OUR TERMINALS ARE MADE IN THE U.S.A.

Our terminals have passed stringent pull and vibration tests conducted by one of the Big Three auto makers. The special tin plating gives them twice the corrosion resistance.

Many of our terminals are now Funnel Entry, UL listed & CSA approved.

Ring Terminals

22-18 AWG

16-14 AWG

12-10 AWG



#6 #8 #10 1/4"



5/16" 3/8" 1/2"



Wire Range AWG Color	Stud Size	Vinyl Part Number	Nylon Part Number	Heat Shrink Part Number	Non-insulated Part Number
22-18 Red	#6	RR6	RR6-N		R2218-6
22-18 Red	#8	RR8	RR8-N	HS-RR8	R2218-8
22-18 Red	#10	RR10	RR10-N	HS-RR10	R2218-10
22-18 Red	1/4"	RR14	RR14-N	HS-RR14	R2218-14
22-18 Red	5/16"	RR516	RR516-N	HS-RR516	R2218-516
22-18 Red	3/8"	RR38	RR38-N	HS-RR38	R2218 -38
16-14 Blue	#6	BR6	BR6-N		R1614-6
16-14 Blue	#8	BR8	BR8-N	HS-BR8	R1614-8
16-14 Blue	#10	BR10	BR10-N	HS-BR10	R1614-10
16-14 Blue	1/4"	BR14	BR14-N	HS-BR14	R1614-14
16-14 Blue	1/2"	BR12	BR12-N	HS-BR12	R1614-12
16-14 Blue	5/16"	BR516	BR516-N	HS-BR516	R1614-516
16-14 Blue	3/8"	BR38	BR38-N	HS-BR38	R1614-38
12-10 Yellow	#6	YR6			R1210-6
12-10 Yellow	#8	YR8	YR8-N	HS-YR8	R1210-8
12-10 Yellow	#10	YR10	YR10-N	HS-YR10	R1210-10
12-10 Yellow	1/4"	YR14	YR14-N	HS-YR14	R1210-14
12-10 Yellow	5/16"	YR516	YR516-N	HS-YR516	R1210-516
12-10 Yellow	3/8"	YR38	YR38-N	HS-YR38	R1210-38
12-10 Yellow	1/2"	YR12		HS-YR12	

For 3M Terminals Go to Page 26 to 27

IF YOU ARE LOOKING FOR SOMETHING SPECIAL CALL HAINES AND LET US KNOW.
ALSO CHECK OUR WEBSITE FOR THE LATEST PRODUCT INFORMATION



RING TERMINALS

MANY OF OUR TERMINALS ARE MADE IN THE U.S.A.

Our terminals have passed stringent pull and vibration tests conducted by one of the Big Three auto makers. The special tin plating gives them twice the corrosion resistance. Many of our terminals are now Funnel Entry, UL listed & CSA approved.



Ring Terminals Large Gauge

Wire Range AWG Color	Stud Size	Vinyl Part Number	Nylon Part Number	Heat Shrink Part Number	Non-insulated Part Number
8 Red	#8	RR8-8			
8 Red	#10	RR810		HS-RR810	R810
8 Red	1/4"	RR814			R814
8 Red	1/2"	RR812	RR812-N		R812
8 Red	5/16"	RR8516		HS-RR8516	R8516
8 Red	3/8"	RR838		HS-RR838	R838
6 Blue	#10	BR610			R610
6 Blue	1/4"	BR614			R614
6 Blue	3/8"	BR638			R638
6 Blue	5/16"	BR6516			R6516
6 Blue	1/2"	BR612			R612
4 Yellow	#10				R410
4 Yellow	1/4"				R414
4 Yellow	5/16"	YR4516			R438
4 Yellow	3/8"	YR438			R4516
4 Yellow	1/2"				R412

For 3M Terminals Go to Page 26 to 27

IF YOU ARE LOOKING FOR SOMETHING SPECIAL CALL HAINES AND LET US KNOW. ALSO CHECK OUR WEBSITE FOR THE LATEST PRODUCT INFORMATION



SPADE TERMINALS

MANY OF OUR TERMINALS ARE MADE IN THE U.S.A.

Our terminals have passed stringent pull and vibration tests conducted by one of the Big Three auto makers. The special tin plating gives them twice the corrosion resistance.

Many of our terminals are now Funnel Entry, UL listed & CSA approved.

Spade Terminals

22-18 AWG #6 #8 #10 1/4"
 16-14 AWG ● ● ● ●
 12-10 AWG



Wire Range AWG Color	Stud Size	Vinyl Part Number	Nylon Part Number	Heat Shrink Part Number	Non-insulated Part Number
22-18 Red	#6	RS6	RS6-N		S2218-6
22-18 Red	#8	RS8	RS8-N	HS-RS8	S2218-8
22-18 Red	#10	RS10	RS10-N	HS-RS10	S2218-10
22-18 Red	1/4"	RS14			
16-14 Blue	#6	BS6	BS6-N		S1614-6
16-14 Blue	#8	BS8	BS8-N	HS-BS8	S1614-8
16-14 Blue	#10	BS10	BS10-N	HS-BS10	S1614-10
16-14 Blue	1/4"	BS14			S1614-14
12-10 Yellow	#6	YS6	YS6-N		S1210-6
12-10 Yellow	#8	YS8	YS8-N	HS-YS8	S1210-8
12-10 Yellow	#10	YS10	YS10-N	HS-YS10	S1210-10
12-10 Yellow	1/4"	YS14			

For 3M Terminals Go to Page 26 to 27

Flanged Spades

Tips are bent to hold screw head. Cannot pull out once screw is tightened. Vinyl



Part Number	Wire Range AWG Color	Size
RSF6	22-18 Red	#6
RSF8	22-18 Red	#8
RSF10	22-18 Red	#10
BSF6	16-14 Blue	#6
BSF8	16-14 Blue	#8
BSF10	16-14 Blue	#10

IF YOU ARE LOOKING FOR SOMETHING SPECIAL CALL HAINES AND LET US KNOW. ALSO CHECK OUR WEBSITE FOR THE LATEST PRODUCT INFORMATION



FEMALE QUICK DISCONNECT TERMINALS



MANY OF OUR TERMINALS ARE MADE IN THE U.S.A.

Female Quick Disconnects



Wire Range AWG Color	Blade Size	Vinyl Part Number	Nylon Part Number	Heat Shrink Part Number	Non-insulated Part Number
22-18 Red	.110	RF110			
22-18 Red	.187	RF187			QDF2218187
22-18 Red	.205	RF205			
22-18 Red	.250	RF250	RF250-N	HS-RF250	QDF2218250
16-14 Blue	.110	BF110			
16-14 Blue	.187	BF187			QDF1614187
16-14 Blue	.205	BF205			
16-14 Blue	.250	BF250	BF250-N	HS-BF250	QDF1614250
12-10 Yellow	.250	YF250	YF250-N	HS-YF250	QDF1210250
12-10 Yellow	.375	YF375			

Female Fully Insulated Quick Disconnects



Wire Range AWG Color	Blade Size	Nylon Part Number	Flag Type Nylon Part Number	Heat Shrink Part Number	
22-18 Red	.110"	RFN-110			
22-18 Red	.187"	RFN-187			
22-18 Red	.250"	RFN	RFN-FLAG	HS-RFN	
16-14 Blue	.187"	BFN-187			
16-14 Blue	.250"	BFN	BFN-FLAG	HS-BFN	
12-10 Yellow	.250"	YFN		HS-YFN	

For 3M Terminals Go to Page 26 to 27

IF YOU ARE LOOKING FOR SOMETHING SPECIAL CALL HAINES AND LET US KNOW. ALSO CHECK OUR WEBSITE FOR THE LATEST PRODUCT INFORMATION



MALE QUICK DISCONNECT TERMINALS



MANY OF OUR TERMINALS ARE MADE IN THE U.S.A.

Male Quick Disconnects



Wire Range AWG Color	Blade Size	Vinyl Part Number	Heat Shrink Part Number	Nylon Part Number	Non-insulated Part Number
22-18 Red	.187"	RM187			
22-18 Red	.250"	RM250	HS-RM250	RM250-N	QDM2218250
16-14 Blue	.187"	BM187			
16-14 Blue	.250"	BM250	HS-BM250	BM250-N	QDM1614250
12-10 Yellow	.250"	YM250	HS-YM250	YM250-N	QDM1210250

Male Fully Insulated Quick Disconnects



Wire Range AWG Color	Blade Size	Nylon Part Number	Heat Shrink Part Number
22-18 Red	.250"	RMN	HS-RMN
16-14 Blue	.250"	BMN	HS-BMN
12-10 Yellow	.250"	YMN	HS-YMN

Female and Male Bullet Connectors



Wire Range AWG Color	Size	Vinyl Part Number	Nylon Part Number	Heat Shrink Part Number
Female 22-18 Red	.157"	RBTF157	RBTF157-N	HS-RBTF157
Female 16-14 Blue	.157"	BBTF157	BBTF157-N	HS-BBTF157
Male 22-18 Red	.157"	RBTM157		HS-RBTM157
Male 16-14 Blue	.157"	BBTM157		HS-BBTM157

For 3M Terminals Go to Page 26 to 27

IF YOU ARE LOOKING FOR SOMETHING SPECIAL CALL HAINES AND LET US KNOW. ALSO CHECK OUR WEBSITE FOR THE LATEST PRODUCT INFORMATION



BUTT SPLICES & TAP CONNECTORS



MANY OF OUR TERMINALS ARE MADE IN THE U.S.A.

Our terminals have passed stringent pull and vibration tests conducted by one of the Big Three auto makers. The special tin plating gives them twice the corrosion resistance.

Many of our terminals are now Funnel Entry, UL listed & CSA approved.

Butt Splice Terminals



Wire Range AWG Color	Vinyl Part Number	Nylon Part Number	Heat Shrink Part Number	Non-insulated Part Number	3M Vinyl Part Number	3M Nylon Part Number
22-18 Red	RBS	RBSN	HS-RBS	B2218	3M61P	3M61SN
16-14 Blue	BBS	BBSN	HS-BBS	B1614	3M62P	3M62SN
12-10 Yellow	YBS	YBSN	HS-YBS	B1210	3M63P	3M63SN
8 AWG Red	RBS8		HS-RBS8			
6 AWG Blue	BBS6					
4 AWG Yellow	YBS4					

Piggyback Adapters

Vinyl



HEAT SHRINK NO CRIMP BUTT CONNECTORS



No crimp moisture proof solder butts in a one step operation. Each connection solders, insulates, encapsulates and relieves wire strain. When heated with a heating tool the sleeve shrinks and the solder melts and flows,

Resulting in a perfectly sealed solder connection.

Wire Range AWG Color	Part Number	Wire Range AWG Color	Part Number
22-18 Red	RPB	22-18 Red	HSS-RBS
16-14 Blue	BPB	16-14 Blue	HSS-BBS
		12-10 Yellow	HSS-YBS

For 3M Terminals Go to Page 26 to 27

IF YOU ARE LOOKING FOR SOMETHING SPECIAL CALL HAINES AND LET US KNOW. ALSO CHECK OUR WEBSITE FOR THE LATEST PRODUCT INFORMATION



MISCELLANEOUS & TAP CONNECTORS



MANY OF OUR TERMINALS ARE MADE IN THE U.S.A.

T-Taps



Wire Range AWG Color	Part Number
22-18 Red	RT-TAP
16-14 Blue	BT-TAP
12-10 Yellow	YT-TAP

Quick Splice (Scotchloks)



Wire Range AWG Color	Part Number
16-14 Blue	BTS
22-18 Red	RTS
12-10 Yellow	YTS
All Ports Open	WTS

Clear Nylon Crimp Caps



Wire Range AWG Color	Haines Part Number
22-18 Clear	CES2214
18-10 Clear	CES1210

WIRE NUTS



Wire Range AWG Color	Part Number
Yellow	WN1 No Metal Insert
Grey	GWN
Blue	BWN
Orange	OWN
Yellow	YWN
Red	RWN
Yellow Winged	YWN/W
Red Winged	RWN/W

IF YOU ARE LOOKING FOR SOMETHING SPECIAL CALL HAINES AND LET US KNOW. ALSO CHECK OUR WEBSITE FOR THE LATEST PRODUCT INFORMATION

Heat Shrink Installation Instructions

Select the correct terminal size for the wire gauge. Strip the wires 5/16" from the end and insert in the crimp barrel, Making sure the wire end is properly sealed, make the terminal crimp connection using a tool designed for insulated terminals.

Apply heat directly to the splice, working from the center out to the edges using a hot air gun or other heat source until the tubing shrinks and the adhesive flows. *Allow to cool before inspecting splice and checking integrity.*

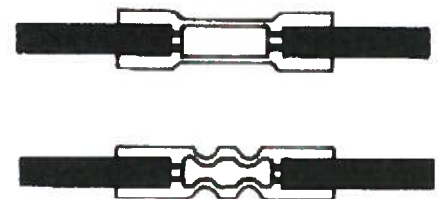
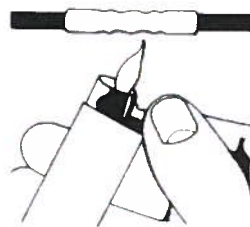

VINYL TERMINAL KIT

KIT CONTAINS THE FOLLOWING TERMINALS.

Part Number	QTY	Part Number	QTY	Part Number	QTY
RBS	12	BM250	12	BS10	10
RF250	12	BR6	12	YBS	5
RR10	12	BR8	12	YF250	5
RS10	12	BR10	12	YR10	5
BBS	12	BR1/4	10	YR1/4	5
BF250	12	BS6	10	YR3/8	5



Part Number	Description
HP175K	175 pc Terminal Kit no Tool
HP175KWT	175 pc Terminal Kit with Tool

NON-INSULATED TERMINAL KIT

KIT CONTAINS THE FOLLOWING TERMINALS.

Part Number	QTY	Part Number	QTY	Part Number	QTY	Part Number	QTY
B2218	100	R2218-1/4	100	R2218-3/8	100	S2218-8	100
B1614	100	R1614-1/4	100	R1614-3/8	100	S1614-8	100
B1210	100	R1210-1/4	100	R1210-3/8	100	S1210-8	100
R2218-8	100	R2218-5/16	100	QDF2218-250	100	S2218-10	100
R1614-8	100	R1614-5/16	100	QDF1614-250	100	S1614-10	100
R1210-8	100	R1210-5/16	100	QDF1210-250	100	S1210-10	100



Part Number	Description
HP2400K	Non-Insulated Terminal Kit

HEAT SHRINK TERMINAL KIT

KIT CONTAINS THE FOLLOWING TERMINALS.

Part Number	QTY	Part Number	QTY	Part Number	QTY
HS-RBS	20	HS-BR10	10	HS-RFN	10
HS-BBS	20	HS-BR1/4	10	HS-BFN	10
HS-YBS	20	HS-BR3/8	10	HS-YFN	10
HS-RR8	10	HS-YR10	10	HS-RMN	10
HS-RR10	10	HS-YR5/16	10	HS-BMN	10
HS-BR8	10	HS-YR3/8	10	HS-YMN	10



Part Number	Description
HP210K	Heat shrink Terminal Kit

COPPER TERMINAL KIT

KIT CONTAINS THE FOLLOWING TERMINALS.

Part Number	QTY	Part Number	QTY	Part Number	QTY	Part Number	QTY
HCL814	10	HCL638	10	HCL256	10	HCL1056	10
HCL856	10	HCL600	10	HCL238	10	HCL1038	10
HCL838	10	HCL414	10	HCL156	10	HCL1050	10
HCL800	10	HCL456	10	HCL138	10	HCL2056	5
HCL614	10	HCL438	10	HCL150	10	HCL2038	5
HCL656	10	HCL400	10	HCL1014	10	HCL2050	5



Part Number	Description
HP225K	Copper Lug Terminal Kit



HONDA SMART FIX KITS



Honda Smart Fix Kit PD-HON1

2106T



8MM SCREW IN RETAINER
Head Dia: 20mm
Stem Length: 9mm
OEM# 90675-5B-003
20 pcs.

2009T



8MM SCREW IN RETAINER
5/16" (8mm) Hole; 18mm
Stem; 20mm Flange
OEM#: 63844-01A00
20 pcs.

2122T



8MM HOLE RETAINER
20mm Head Diameter;
11mm Stem Length
OEM#: 91512-SXO-003
18 pcs.

2125T



**8MM HONDA FENDER
SPLASH SHIELD**
8mm Hole Size; 20mm
Head Dia; 9mm Stem
Length
OEM#: 91512-SM4-003
18 pcs.

2159T



8MM SCREW RIVET
8mm Hole Size; 18mm
Head Diameter; 21mm
Stem Length
OEM #: 90505-SM4-003
14 pcs.

2144T



**10MM HOLE ACURA BUMPER
RETAINER; 20mm Head
Diameter; 15mm Stem
Length;**
OEM#: 91503-SP0-003
16 pcs.



Honda Retainer-Smart Fix Kit PD-HON2

2117T



HOOD SEAL RETAINER
7mm x 16mm Head; 5mm
Hole; 12mm Stem;
OEM # 91513-SEO-003
35 pcs.

2118T



WEATHER STRIP CLIP;
6mm Hole; 10mm Stem;
5mm x 15mm Head; Honda
Accord, Civic, & Odyssey
1992 & On,
OEM # 91530-SP1-003
40 pcs.

2119T



WEATHERSTRIP CLIP
5mm Hole; 6.5mm x
16.5mm Head; 10.5mm
Stem;
OEM# 4696129
40 pcs.

2137T



**6MM HOOD
INSULATION CLIP;**
10mm Head; 10mm Stem;
4mm Panel Thickness;
Honda & Acura 1990 & On
OEM#: 91520-SM4-C010
40 pcs.

2188T



HOOD RETAINER
6MM Hole Size; 12mm
Head; 9mm Stem; Hood &
Trunk Moulding; Acura
Integra & Honda Civic;
OEM#: 91518-SM4-003
35 pcs.

2925T



19/64" HOOD CLIP
Fits 7.5mm Hole; 30mm
Head Diameter
OEM#: 90700-S14-000
10 pcs.



GM SMART FIX KITS



GM Door Panel Smart Fix Kit PD-GM1

2015T



DOOR TRIM PANEL CLIP
NYLON, 29/32" Top Head;
7/8" Bottom Head; 5/16"
Stem Diameter, 3/4" Stem
Length, OEM # 3065575
20 pcs.

2161T



GM DOOR PANEL CLIP;
3/4" Bottom Head
Diameter; 5/8" Top Head;
5/16" Stem Dia.; 1" Stem
Length OEM# 363137
18 pcs.

2191T



1/4" PUSH-TYPE WHITE
NYLON DOOR PANEL CLIP;
9/16" Head Diameter;
41/64" Stem Length
GM # 15960325
15 pcs.

2949T

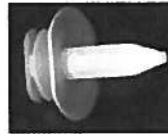

GM DOOR TRIM PANEL CLIP;
9/32" x 19/32" Top Hd Dia;
3/4" x 7/8" Btm Hd; 5/16"
Stem Dia; 3/4" Stem Lgth;
OEM#204221800
20 pcs.

2917T

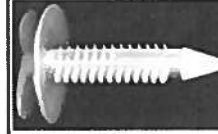

GM DOOR TRIM PANEL
CLIP;
29/32" Top Hd Dia.; 15/16"
Btm Hd Dia.; 5/16" Stem
Dia.; 1 1/4" Stem Length;
OEM#10126901
14 pcs.

2918T

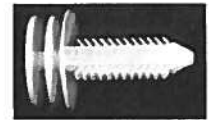

GM DOOR TRIM PANEL CLIP;
20mm Bottom Head Dia.;
18mm Top Head Dia.; 8mm
Stem Diameter; 23mm Stem
Length; OEM# 10153057
18 pcs.

TOYOTA SMART FIX KITS

Toyota Smart Fix Kit PD-TOY1

2947T



7MM SCREW IN CLIP
17/64" Hole Size; 15mm
Head Dia; 12mm Stem
Length
OEM #: 90467-06017
25 pcs.

20045T



7MM FENDER PUSH IN
CLIP
Head Dia: 18mm, Stem
length: 7.5mm
OEM #:90467-10183
12 pcs.

2146T



7MM FRONT FENDER
PUSH IN RIVET
20mm Head Dia; 8mm Stem
Length; Tercel 1994 & On;
OEM #:90467-07166
16 pcs.

2130T



9MM BUMPER COVER
CLIP
23/64" Hole Size; 15mm
Head Dia. 12mm Stem
Length;
OEM #: 90467-09145
15 pcs.

2123T



9MM BUMPER COVER
CLIP
18mm Head Dia. ; 23mm
Stem Length; ES-300 '93 &
on
OEM#: 90467-09101
16 pcs.

2157T



9MM BUMPER COVER
CLIP;
18mm Head Dia; 28mm
Stem Length;
OEM # 52161 16010;
52161 02020
12 pcs.

TOYOTA SMART FIX KITS

Toyota Smart Fix Kit PD-TOY2

2093T



**5MM HOLE SIZE
RETAINER**
13mm Head; 11mm Stem;
OEM # 90467-08004, 90467-
08011;
2.5 pcs.

2114T



RETAINING CLIP
13mm Head Diameter;
15mm Stem Length; 5mm
Hole; 3mm Panel Thickness
OEM # 90467-07050;
25 pcs.

20048T



**BLUE NYLON MOULD-
ING CLIP**
Stem: 10mm Head Dia:
17mm Rocker Moulding 4-
Runner '03 & Up
OEM#: 75495-35010
10 pcs.

20047T



**ORANGE NYLON MOULD-
ING CLIP**
Fits 9mm square hole. Head
Dia: 17mm Toyota & Lexus
'03 & Up
OEM#: 75495-35010
10 pcs.

2902T



**HOOD INSULATION
RETAINER**
7mm Hole; 25mm Head
Diameter; 10mm Stem
Length;
OEM # 90467-09050
12 pcs.

2089T



7MM HOLE HOOD CLIP
30mm Hd Dia; 17mm
Stem ; 6mm Panel Thickness
OEM # 90467-09008
15 pcs.



Toyota Smart Fix Kit PD-TOY3

2124T



10 SCREW GROMMET
Fits 8.5mm Square Hole,
13mm Wide; 13mm Long;
OEM #: 90189-06018
25 pcs.

2109T



#8 SCREW GROMMET
16mm Head; 17mm
Stem; Fits 8 x 8mm Hole;
OEM#: 90189-06042
20pcs.

2908T



#12 SCREW GROMMET
FENDER LINER;
16mm Head Diameter;
19mm Stem Length;
OEM#:90189-06028,
94854203
20 pcs.

2979T



12 SCREW GROMMET
Stem: 22mm Head Dia:
20mm
OEM #: 90189-06157
15 pcs.

2068T



1/4" SCREW GROMMET
6.3-1.81mm Screw Size
Head Dia 20mm; 17mm
Stem Length
OEM # 90189-06013
16 pcs.

2069T



#10 PLASTIC "U" NUT
20mm wide x 31mm Long;
Up to 1mm Panel Range;
11mm Center of Hole To Edge
OEM# :53879-14010A, 53879
-14020, 53879-22030;
14 pcs.



NISSAN SMART FIX KITS



Nissan Retainer Smart Fix Kit PD-NIS1

2127T



NISSAN FRONT & REAR BUMPER CLIP;
Stem: 15mm; Hole: 8MM;
Head Dia: 20mm;
OEM#: 01553-06721
15 pcs

2009T



SCREW IN RETAINER (8mm)
5/16" (8mm) Hole; 18mm
Stem; 20mm Flange
OEM#: 63844-01A00
20 pcs

2150T



10MM FRONT FENDER PUSH RETAINER;
25/64" (10mm) Hole; 18mm
Head; 15mm Stem
2405X & Maxima 1994 & On
OEM#: 01553-09321
15 pcs.

2141T



10MM BUMPER CLIP;
25/64" Hole; 18mm Head;
15mm Stem
2405X & Maxima 1994 & On
OEM#: 01553-09241
15 pcs.

20034T



8MM HOLE FRONT BUMPER CLIP
Head Dia: 20mm, Stem
length: 13mm
OEM #: 11296-AG000
12 pcs.

2145T



HOOD INSULATION CLIP
38mm O.D.; 7mm Stem
Diameter; 9mm Stem
Length
OEM #: 65846-30F00;
65832-F5000
12 pcs.

OTHER SMART FIX KITS

License Plate Screw Smart Fix Kit PD-LPK

2066T



LICENSE PLATE SCREW
Slotted Head (14 X 3/4")
40 pcs.

20035T



6-1.0 X 16MM LICENSE
PLATE SCREW
Zinc Finish Machine
Screw
40 pcs.

2903T



1/4" (#14) X 3/4" PHILLIPS
WASHER HEAD LICENSE
PLATE SCREW
(YELLOW ZINC)
OEM #91500-SM4-999AH
30 pcs.

2112T



SLOTTED HD LICENSE
PLATE SCREW
#14 X 3/4"
Chrome Finish
30 pc.

20003T



SLOTTED HD LICENSE
PLATE SCREW
#14 X 3/4"
Black Finish
25 pcs.

2904T



PHILLIPS TRUSS HEAD
LICENSE PLATE SCREW
1/4" (#14) X 3/4"
25 pcs.



OTHER SMART FIX KITS



Foreign Door Panel Smart Fix Kit

PD-EURO1

2193T

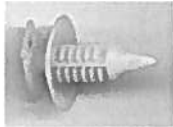

VW & AUDI DOOR PANEL CLIP;
14mm Top Head Dia.; 18mm Bottom Head; 9mm Stem Dia; 14mm Stem;
OEM #:171-867-299B
15 pcs.

2944T



9MM HONDA DOOR PANEL CLIP
OEM# 91566-SPO-003
15 pcs.

2158T



9MM TOYOTA DOOR PANEL CLIP; 13mm Top Head; 15.5mm Middle Head; 18mm Bottom Head; 9.5mm Stem Dia; 14mm Stem Length; 20.5mm Overall Length
OEM# 67771-01010 (12010)
20 pcs.

2166T



9MM TOYOTA DOOR PANEL CLIP; 13mm Top Head; 15.5mm Middle Head; 18mm Bottom Head; 9.5mm Stem Dia;
Toyota # 67771-01010 (12010)
20 pcs.

2163T



FOREIGN DOOR PANEL CLIP; 13mm Top Head; 16mm Middle Head; 15mm Bottom Head; 9.5mm Stem Diameter; Toyota # 67771-30070
20 pcs.

20017T



BMW DOOR PANEL CLIP
Series 3, 5 & 7 1987-On
OEM# 51-41-1-973-5000
15 pcs.

DASH & SPEED CLIP SMART FIX KITS

Dashboard Screw Smart Fix Kit

PD-DASH

2031T



4.2MM X 20MM BLACK SCREW;
#8 x 25/32", Phillips Washer Head Pozl Drive; 11mm (7/16") Washer O.D.
GM# 11501884
50 pcs.

2039T



#8 X 3/4" BLACK TRIM SCREW 3/8" O.D.
50 pcs.

2040T



#8 X 1" BLACK TRIM SCREW 3/8" O.D.
50 pcs.

20039T



#10 X 3/4" BLACK TRIM SCREW 1/2" O.D.
40 pcs.

2016T



4.2 X 20MM INDENTED HEX HD. BLACK SHEET METAL SCREW
w/ 17MM Washer (7MM Hex)
GM# 11503892; 1640810, 11500434
30 pcs

2030T



4.2X20MM INDENTED HEX HD. BLACK SHEET METAL SCREW
w/ 12MM Washer (7MM Hex)
GM# 11503396
30 pcs.



COPPER TERMINALS



LUGS - STANDARD WALL

- Solid copper for maximum conductivity.
- One - piece seamless construction.



Part Number	Wire Range AWG Color	Size
HCL810	8	#10
HCL814	8	1/4"
HCL838	8	3/8"
HCL850	8	1/2"
HCL856	8	5/16"
HCL610	6	#10
HCL614	6	1/4"
HCL638	6	3/8"
HCL650	6	1/2"
HCL656	6	5/16"
HCL410	4	#10
HCL414	4	1/4"
HCL438	4	3/8"
HCL450	4	1/2"
HCL456	4	5/16"
HCL214	2	1/4"
HCL238	2	3/8"
HCL250	2	1/2"
HCL256	2	5/16"
HCL114	1	1/4"
HCL138	1	3/8"
HCL150	1	1/2"
HCL156	1	5/16"
HCL1014	1/0	1/4"
HCL1038	1/0	3/8"
HCL1050	1/0	1/2"
HCL1056	1/0	5/16"
HCL2014	2/0	1/4"
HCL2038	2/0	3/8"
HCL2050	2/0	1/2"
HCL2056	2/0	5/16"

Part Number	Wire Range AWG Color	Size
HCL3014	3/0	1/4"
HCL3038	3/0	3/8"
HCL3050	3/0	1/2"
HCL3056	3/0	5/16"
HCL4014	4/0	1/4"
HCL4038	4/0	3/8"
HCL4050	4/0	1/2"
HCL4056	4/0	5/16"

BUTT CONNECTOR

- Made of solid copper and tinned for extra corrosion resistance.
- Flared ends permit easy cable insertion.
- Color Coded - available call or fax for a quote.



Part Number	Wire Range AWG Color
HCL800	8
HCL600	6
HCL400	4
HCL200	2
HCL100	1
HCL1000	1/0
HCL2000	2/0

POWER CRIMPER Crimps 6 to 4/0 Gauge. Compound leverage design and precision calibration

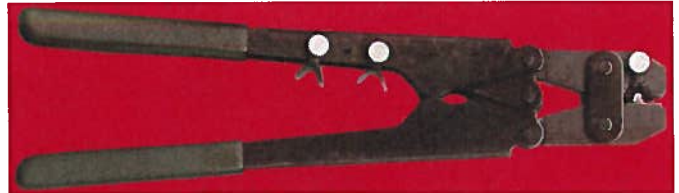

Part Number

KL006

CRIMPER - HAMMER STYLE



Part Number

BHC-1

ALLIGATOR CLIP

1-1/4" long



Part Number	Size
AC1	1-1/4"

ALLIGATOR CLIP BOOT ONLY



Part Number	Size
ACBI-1	1-1/4"
ACRI-1	1-1/4"

ALLIGATOR CLIP

1 3/8" long



Part Number	Size
AC1.37	1-3/8"

ALLIGATOR CLIP

2" long no screw



Part Number	Size
AC2NS	2"

ALLIGATOR CLIP

2" long with screw



Part Number	Size
AC2	2"

ALLIGATOR CLIP

2" long with handle



Part Number	Size
AC2WHB	2"
AC2WHR	2"

ALLIGATOR CLIP BOOT ONLY

2" long boot



Part Number	Size
ACBI-2K	2"
ACRI-2K	2"

ALLIGATOR CLIP

with no screw



Part Number	Size
AC1462	2"

BATTERY CLIP

50 AMP (copper Plated)
75 AMP (Solid Copper)
Marked (+) & (-)

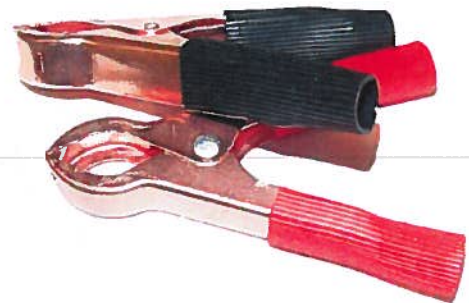

Part Number	Size
BC50B	2-3/4"
BC50R	2-3/4"
BC75B (Solid Copper)	2-3/4"
BC75R (Solid Copper)	2-3/4"

CHARGING CLIPS

10 AMP, 25 AMP and 50 AMP



Part Number	Size
TC10	10 AMP
TC25	25 AMP
TC50	50 AMP

SNAP GROMMETS

Protects wires from sharp edges.
Easy snap-in but takes more than 35 lbs. to back out.



Part Number	O.D.	Approx. Gauge	I.D.
SNP2	5/16"	10 AWG	3/16"
SNP3	7/16"	8 AWG	5/16"
SNP4	1/2"	4 AWG	3/8"
SNP5	3/4"	1 AWG	39/64"
SNP6	61/64"		49/64"
SNP7	21/32"		7/16"
SNP8	1 7/8"		1 3/8"
SNP9	1 39/64"		1 5/16"
SNP12	2 21/32"		1 31/32"

RUBBER GROMMETS

Protects wires from sharp edges.
Easy snap-in but takes more than 35 lbs. to back out.



Part Number	O.D.	Approx. Gauge	I.D.
HRG1	1/8"	16 AWG	5/16"
HRG2	3/16"	10 AWG	3/8"
HRG3	1/2"		1/4"
HRG4	5/16"	8 AWG	9/16"
HRG5	3/8"	4 AWG	5/8"
HRG6	5/8"		1/2"

DOME HOLE PLUGS



Part Number	Size
DP3/4	3/4"
DP1	1"

WASHERS

Fender, Large Fender & Mini Washers



Part Number	Size
MW8	#8 x 7/16" O.D.
HW3/8	3/8" x 1" O.D.
FENWAS	1/4" x 1 1/4" O.D.

FINISHING WASHERS

Black for #8 screw.



Part Number	Size
HFV	#8

LOCK WASHER



Part Number	Size & Description
HLW8	#8 External
HLW10	#10 Int /Ext

SPEED CLIPS

Black



Part Number	Size	Type
HSCF	#8	Flat
HSCS	#8	Short
H_SCL	#8	Long
H_SCL10	#10	Long



SCREWS



PHILLIPS TRUSS HEAD

Black Oxide.



Part Number	Size
PTH8x1/2	#8x1/2"
PTH8x1	#8x1"
PTH10x1/2	#10x1/2"
PTH10x1	#10x1"

PHILLIPS WAFER HEAD STINGER SUPER SHARP.

Black Oxide.



Part Number	Size
PWS8x1/2	#8x1/2"
PWS8x3/4	#8x3/4"
PWS8x1	#8x1"

PHILLIPS WAFER HEAD TEK

Black Oxide. Self Drilling.
(S)= CLEAR ZINC



Part Number	Size
PWH8x1/2-S	#8x1/2"
PWH8x1/2	#8x1/2"
PWH8x3/4	#8x3/4"
PWH8x1	#8x1"

PHILLIPS PAN HEAD

Black Oxide



Part Number	Size
PPH8x1/4	#8x1/4"
PPH8x1/2	#8x1/2"
PPH8x3/4	#8x3/4"
PPH8x1	#8x1"
PPH8x1 1/2	#8x1 1/2"
PPH8x2	#8x2"
PPH8x3	#8x3"
PPH10x1/2	#10x1/2"
PPH10x3/4	#10x3/4"
PPH10x1	#10x1"

PHILLIPS OVAL HEAD

Black Oxide.



Part Number	Size
POH8x1/2	#8x1/2"
POH8x3/4	#8x3/4"
POH8x1	#8x1"
POH8x1 1/2"	#8x1 1/2"
POH8x2	#8x2"

HEX WASHER HEAD

Black Oxide. #8 screws have 1/4" head.#10 screws have 5/16" head. (S)= CLEAR ZINC



Part Number	Size
HWH8x1/2	#8x1/2"
HWH8x3/4	#8x3/4"
HWH8x3/4-S	#8x3/4"
HWH8x1	#8x1"
HWH8x1 1/2"	#8x1 1/2"

SUPER SHARP STINGERS

Black Oxide.



Part Number	Size
SSS6x1	#6x1"
SSS6x1 1/4	#6x1 1/4"
SSS6x1 1/2	#6x1 1/2"
SSS6x2	#6x2"
SSS8x2	#8x3"
SSS8x3	#8x3"
SSS10x2	#10x2"

HEX WASHER HEAD TEK

Black Oxide. Self Drilling.



#8 Screws have 1/4" Head

#10 Screws have 5/16" Head (S)= CLEAR ZINC

Part Number	Size
HWHT8x1/2	#8x1/2"
HWHT8x1/2-S	#8x1/2"
HWHT8x3/4	#8x3/4"
HWHT8x1	#8x1"
HWHT8x1 1/2	#8x1 1/2"
HWHT10x1/2	#10x1/2"
HWHT10x1/2-S	#10x1/2"
HWHT10x3/4	#10x3/4"
HWHT10x1	#10x1"
HWHT10x1 1/4	#10x1 1/4"
HWHT10x1 1/2	#10x1 1/2"

PHILLIPS PAN HEAD TEK

Black Oxide. Self Drilling.



(S)= CLEAR ZINC

Part Number	Size
PPHT8x1/2	#8x1/2"
PPHT8x1/2-S	#8x1/2"
PPHT8x3/4	#8x3/4"
PPHT8x1	#8x1"
PPHT10x1/2	#10x1/2"
PPHT10x1/2-S	#10x1/2"
PPHT10x1	#10x1"

CABLE TIES

MANY OF OUR PRODUCTS ARE MADE IN THE U.S.A.

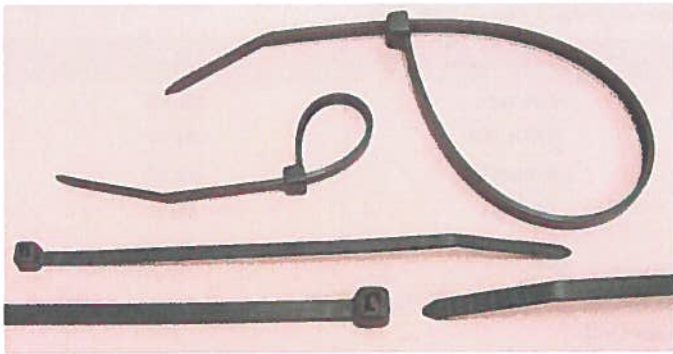

BLACK UV. CABLE TIES

Fastens Wires, Cables, Hoses and Ducts

Material Specifications

Nylon 6/6 Weather Resistant.

A general purpose nylon with carbon BLACK to provide resistance to ultraviolet light and features light weight, high strength and a broad range of operating temperatures. Nylon 6/6 is Hydroscopic and, therefore absorbs or releases moisture depending on its environment. Moisture level of the material will affect the tensile strength, stiffness and elongation of the product.

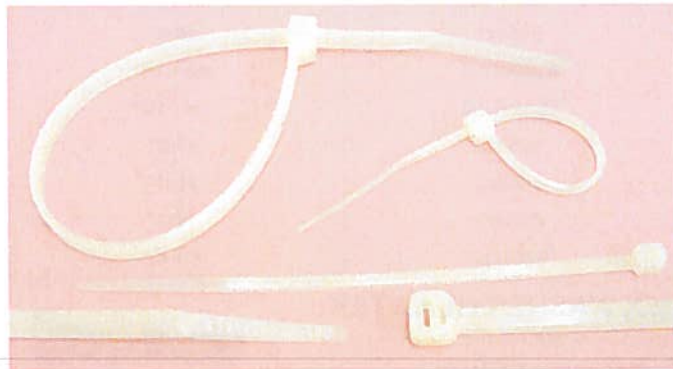

NATURAL CABLE TIES

Fastens Wires, Cables, Hoses and Ducts

Material Specifications

Nylon 6/6 General Purpose

A general purpose nylon that features light weight, high strength and a broad range of operating temperatures. (natural and colors) Nylon 6/6 is Hydroscopic and, therefore absorbs or releases moisture depending on its environment. Moisture level of the material will affect the tensile strength, stiffness and elongation of the product.

A lightweight tool for least critical Applications. Cinch tie to desired bundle and twist tool to remove the excess strap. Recommended for use with 18-50 pound ties.



Part Number

CTT1

Heavy duty tool with automatic cut-off and adjustable tensioning for dependable use in assembly applications. Recommended for use with 18-50 pound ties



Part Number

CTT-3R

BLACK NYLON CABLE CLAMPS
Screw Mount.



Part Number	Size
HPCC125	1/8"
HPCC187	3/16"
HPCC250	1/4"
HPCC375	3/8"
HPCC500	1/2"
HPCC750	3/4"
HPCC1000	1"

CABLE TIE MOUNTING PADS

Available in Natural or Black.



Part Number	Size	Color
MP3/4-BK	3/4"	Black
MP1-BK	1"	Black
MP3/4-N	3/4"	Natural
MP1-N	1"	Natural

IF YOU ARE LOOKING FOR SOMETHING SPECIAL CALL HAINES AND LET US KNOW. ALSO CHECK OUR WEBSITE FOR THE LATEST PRODUCT INFORMATION



CABLE TIES



STANDARD CABLE TIE 18 TO 175 LBS.

Part Number	Length	Tensile Strength	Color	Width
HP4CT-B	4"	18 lb.	Black UV	
HP4CT-N	4"	18 lb.	Natural	
HP6CT-B	5.75"	30 lb.	Black UV	
HP6CT-N	5.75"	30 lb.	Natural	
HP6CT-18B	5.75"	18 lb.	Black UV	
HP8CT-18B	7.5"	18 lb.	Black UV	
HP8CT-18N	7.5"	18 lb.	Natural	
HP8CT-30B	7.5"	30 lb.	Black UV	
HP8CT-B	7.5"	50 lb.	Black UV	
HP8CT-N	7.5"	50 lb.	Natural	
HP11CT-B	11"	50 lb.	Black UV	
HP11CT-N	11"	50 lb.	Natural	
HP14CT-B	14.5"	50 lb.	Black UV	
HP14CT-N	14.5"	50 lb.	Natural	
HP14CT-BHD	14"	120 LB.	Black UV	
HP14CT-NHD	14"	120 LB.	Natural	
HP18CT-BHD	18"	175 LB.	Black UV	
HP18CT-NHD	18"	175 LB.	Natural	
HP24CT-BHD	24"	175 LB.	Black UV	
HP24CT-NHD	24"	175 LB.	Natural	
HP36CT-BHD	36"	175 LB.	Black UV	
HP36CT-NHD	36"	175 LB.	Natural	
HP48CT-BHD	48"	175 LB.	Black UV	
HP48CT-NHD	48"	175 LB.	Natural	

MOUNTING HOLE CABLE TIE

Mounting hole cable ties have a molded-in screw hole for securing bundles of wire on virtually any Surface that has or can accept a drilled hole.



Part Number	Length	Tensile Strength	Color
MHCT4-B	4"	18 lb.	Black
MHCT4-N	4"	18 lb.	Natural
MHCT6-B	6"	40 lb.	Black
MHCT6-N	6"	40 lb.	Natural
MHCT8-B	8"	50 lb.	Black
MHCT8-N	8"	50 lb.	Natural
MHCT14-BHD	15"	120 lb	Black
MHCT14-N	15"	50 lb	Natural

SPLIT LOOM TUBING MADE IN THE U.S.A.

Premium quality polyethylene convoluted loom split length-wise on one side to make inserting or removing wire easier. Superior crushing strength ,abrasion resistance, and tighter seam closure even when bent or twisted.



Part Number	Length	Color	Size
HPSL14-100	100ft	BLACK	1/4"
HPSL14-4000MG	4000ft	BLACK	1/4"
HPSL38-100	100ft	BLACK	3/8"
HPSL38-2000MG	2000ft	BLACK	3/8"
HPSL12-100	100	BLACK	1/2"
HPSL12-1300MG	1300ft	BLACK	1/2"
HPSL58-100	100ft	BLACK	5/8"
HPSL58-1000MG	1000ft	BLACK	5/8"
HPSL34-100	100ft	BLACK	3/4"
HPSL34-700MG	700ft	BLACK	3/4"
HPSL1-100	100ft	BLACK	1"
HPSL1-500MG	500ft	BLACK	1"

RELEASABLE CABLE TIE

Use for prototype, where wires will be added, or when ties needed for temporary application.



Part Number	Length	Tensile Strength	Color
HP5CT-BRL	5"	18 lb.	Black
HP5CT-NRL	5"	18 lb.	Natural
HP8CT-BRL	8"	50 lb.	Black
HP8CT-NRL	8"	50 lb.	Natural
HP10CT-BRL	10"	50 lb	Black
HP10CT-NRL	10"	50 lb	Natural

SPLIT LOOM CABLE APPLICATION TOOLS



Part Number	Length
CAT-05-PP-BL	.24 DIA
CAT-08-PP	.37 DIA
CAT-155-PP	.63 DIA
CAT-20-PP	.79 DIA
CAT-25-PP	.96 DIA
CAT-32-PP	1.22 DIA



MADE IN THE U.S.A.

- * Recommended for trucks, tractors, cars and general service
- * Fore use at 50 Volts or less
- * Meets SAE J1128 Specifications
- * Stranded annealed, single conductor 100 % copper wire
- * General purpose thermoplastic (GPT)
- * Temperature rating of 80° C (176°F)

PRIMARY WIRE 18 AWG Stranding 16/30
PVC Insulation Satisfaction Guaranteed.
Available in 100, 500 and 1000 ft. spools.

Part Number	Color
AW18-100-BK	Black
AW18-100-BL	Blue
AW18-100-BR	Brown
AW18-100-GN	Green
AW18-100-GY	Gray
AW18-100-OR	Orange
AW18-100-PU	Purple
AW18-100-RD	Red
AW18-100-WH	White
AW18-100YE	Yellow
AW18-500-BK	Black
AW18-500-BL	Blue
AW18-500-BR	Brown
AW18-500-GN	Green
AW18-500-GY	Gray
AW18-500-OR	Orange
AW18-500-PU	Purple
AW18-500-RD	Red
AW18-500-WH	White
AW18-500YE	Yellow
AW18-1000-BK	Black
AW18-1000-BL	Blue
HP18-1000-BR	Brown
AW18-1000-GN	Green
AW18-1000-GY	Gray
AW18-1000-OR	Orange
AW18-1000-PU	Purple
AW18-1000-RD	Red
AW18-1000-WH	White
AW18-1000YE	Yellow

PRIMARY WIRE 16 AWG Stranding 19/29
PVC Insulation Satisfaction Guaranteed.
Available in 100 & 500 ft. spools.

Part Number	Color
AW16-100-BK	Black
AW16-100-BL	Blue
AW16-100-BR	Brown
AW16-100-GN	Green
AW16-100-GY	Gray
AW16-100-OR	Orange
AW16-100-PU	Purple
AW16-100-RD	Red
AW16-100-WH	White
AW16-100YE	Yellow
AW16-500-BK	Black
AW16-500-BL	Blue
AW16-500-BR	Brown
AW16-500-GN	Green
AW16-500-GY	Gray
AW16-500-OR	Orange
AW16-500-PU	Purple
AW16-500-RD	Red
AW16-500-WH	White
AW16-500YE	Yellow

PRIMARY WIRE 12 AWG Stranding 19/25
PVC Insulation Satisfaction Guaranteed.
Available in 100 & 500 ft. spools.

Part Number	Color
AW12-100-BK	Black
AW12-100-RD	Red
AW12-500-BK	Black
AW12-500-RD	Red

PRIMARY WIRE 14 AWG Stranding 19/27
PVC Insulation Satisfaction Guaranteed.
Available in 100 & 500 ft. spools.

Part Number	Color
AW14-100-BK	Black
AW14-100-BL	Blue
AW14-100-BR	Brown
AW14-100-GN	Green
AW14-100-OR	Orange
AW14-100-RD	Red
AW14-100-WH	White
AW14-100YE	Yellow
AW14-500-BK	Black
AW14-500-BL	Blue
AW14-500-BR	Brown
AW14-500-GN	Green
AW14-500-RD	Red
AW14-500-WH	White
AW14-500YE	Yellow

PRIMARY WIRE 10 AWG Stranding 19/23
PVC Insulation Satisfaction Guaranteed.
Available in 100 & 500 ft. spools.

Part Number	Color
AW10-100-BK	Black
AW10-100-RD	Red
AW10-500-BK	Black
AW10-500-RD	Red

PRIMARY WIRE 8 AWG Stranding 19/21
PVC Insulation Satisfaction Guaranteed.
Available in 100 & 500 ft. spools.

Part Number	Color
AW8-100-BK	Black
AW8-100-RD	Red
AW8-500-BK	Black
AW8-500-RD	Red

SPEAKER WIRE

500 ft & 1000 ft.



Part Number	Gauge	Color
SW18-1000	18	Clear
SW16-500	16	Clear
SW14-250	14	Clear
SW14-500	14	Clear

SECURITY ZIP CORD

- ◆ Two conductor
- ◆ One side red, one side black
- ◆



Part Number	Gauge	Length
AZ18-500SP	18	500'
AZ16-500SP	16	500'
AZ14-500SP	14	500'

POWER CABLE

- ◆ Available in black or red



Part Number	Gauge	Color	Length
HPW025-BK	0 Gauge	Black	25'
HPW025-RD	0 Gauge	Red	25'
HPW4100-BK	4 Gauge	Black	100'
HPW4100-BL	4 Gauge	Blue	100'
HPW4100-RD	4 Gauge	Red	100'
HPW4250-BK	4 Gauge	Black	250'
HPW4250-RD	4 Gauge	Red	250'
HPW8250-BK	8 Gauge	Black	250'
HPW8250-RD	8 Gauge	Red	250'
HPW8500BK	8 Gauge	Black	500'
HPW8500RD	8 Gauge	Red	500'



FLUX power and speaker wire strictly follow the American Wire Gauge (AWG) standard ensuring that your amps and speakers are getting the power that they need to perform at their best. The ultra high strand count and frosted PVC jacket on the power wire increases the flexibility making for hassle free installations. Each individual strand of the Oxygen Free Copper wire is plated with a tin to prevent oxidation and provide unmatched reliability



More SCOSCHE Wire products on pages 64 & 82

Part Number	Description
SCX-FP8R-250	Red Flux Power Wire 8 AWG
SCX-FP8C-250	Clear Flux Power Wire 8 AWG
SCX-FP8BL-250	Blue Flux Power Wire 8 AWG
SCX-FP8B-250	Black Flux Power Wire 8 AWG
SCX-FP4R-125	Red Flux Power Wire 4 AWG
SCX-FP4C-125	Clear Flux Power Wire 4 AWG
SCX-FP4BL-125	Blue Flux Power Wire 4 AWG
SCX-FP4B-125	Black Flux Power Wire 4 AWG
SCX-FP0R-50	Red Flux Power Wire 1/0
SCX-FP0C-50	Clear Flux Power Wire 1/0
SCX-FP0BL-50	Blue Flux Power Wire 1/0
SCX-FP0B-50	Frosted Black Flux Power

Ring Terminals



Wire Range AWG Color	Stud Size	Vinyl Part Number
22-18 Red	#6	3M110
22-18 Red	#8	3M111
22-18 Red	#10	3M112
22-18 Red	1/4"	
22-18 Red	5/16"	
22-18 Red	3/8"	3M11-38
16-14 Blue	#6	3M120
16-14 Blue	#8	3M121
16-14 Blue	#10	3M122
16-14 Blue	1/4"	3M123
16-14 Blue	1/2"	
16-14 Blue	5/16"	3M124
16-14 Blue	3/8"	3M125
12-10 Yellow	#6	
12-10 Yellow	#8	3M130
12-10 Yellow	#10	3M131
12-10 Yellow	1/4"	3M132-S
12-10 Yellow	5/16"	3M133
12-10 Yellow	3/8"	3M134
12-10 Yellow	1/2"	3M135

Spade Terminals



Wire Range AWG Color	Stud Size	Vinyl Part Number
22-18 Red	#6	3M316F
22-18 Red	#8	3M317B
22-18 Red	#10	3M318B
16-14 Blue	#6	3M416B-S
16-14 Blue	#8	3M417B
16-14 Blue	#10	3M418B
12-10 Yellow	#6	3M516B
12-10 Yellow	#8	3M517B
12-10 Yellow	#10	3M518B

Female Quick Disconnects



Wire Range AWG Color	Blade Size	Vinyl Part Number	Nylon Part Number
22-18 Red	.110		3M70F
22-18 Red	.187		3M71F-187N
22-18 Red	.250	3M250	3M71F
16-14 Blue	.110		3M72F-110N
16-14 Blue	.187		3M72F-187FN
16-14 Blue	.250	3M2502	3M72F
12-10 Yellow	.250		3M73F

Male Quick Disconnects



Wire Range AWG Color	Blade Size	Vinyl Part Number	Nylon Part Number
22-18 Red	.187	3M72M-187	3M71M-187N
22-18 Red	.250	3M71M	
16-14 Blue	.250	3M72M	
12-10 Yellow	.250	3M73M	

3M SELF STRIPPING ATC FUSEHOLDER

Crimps on to 18 g to 14 g wire. Rated at 20 amps Vinyl

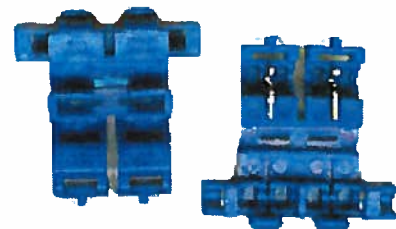

Part Number

3M972

Male Bullet Connectors



Wire Range AWG Color	Size	Vinyl Part Number
22-18 Red	.157"	3M81M
16-14 Blue	.157"	3M82M

Female Bullet Connectors



Wire Range AWG Color	Size	Vinyl Part Number
22-18 Red	.157"	3M81F
16-14 Blue	.157"	3M82F

Butt Splice Terminals



Wire Range AWG Color	3M Vinyl Part Number	3M Nylon Part Number
26-24 - Yellow		3M60SN-A
22-18 Red	3M61P	3M61SN
16-14 Blue	3M62P	3M62SN
12-10 Yellow	3M63P	3M63SN
8GA - Red	3M64-8	

Clear Nylon Crimp Caps



Wire Range AWG Color	3M Part Number
22-18 Clear	3M722
18-10 Clear	3M718

T-Taps



Wire Range AWG Color	3M Part Number
22-18 Red	3M951
16-14 Blue	3M952
12-10 Yellow	3M953

Quick Splice (Scotchloks)



Wire Range AWG Color	3M Part Number
22-16 Red Double Crimp	3M558
16-14 Blue	3M801
18-14 Black	3M901
18-14 / 12-10 Brown	3M902
22-18 Red	3M905

**IF YOU ARE LOOKING FOR SOMETHING SPECIAL
CALL HAINES AND LET US KNOW. ALSO CHECK
OUR WEBSITE FOR THE LATEST PRODUCT
INFORMATION**



3M PRODUCTS



MANY OTHER 3M PRODUCTS AVAILABLE UPON REQUEST

3M HIGHLAND HOOK & LOOP

General purpose hook & loop



Part Number	Size
SJ3532	1" Hook
SJ3533	1" Loop

3M HOOK & LOOP FOR PLASTICIZED VINYL

Specialized adhesive is formulated to bond with today's plasticized vinyls. Use on all flexible vinyls, including floor mats, door panels, and some dashboards. Sticks where others won't.



Part Number	Size
SJ3522	1" Hook
SJ3523	1" Loop

3M DUAL LOCK

5 times stronger than velcro. Sold by the yard. Includes both sides.



Part Number	Size
SJ354	1"

3M HOOK & LOOP DISPENSER BOX

Includes one roll of each hook and loop.



Part Number	Size Description
3MMP26	1" x 5 yd / HOOK N LOOP - MINI PACK
3MMP60	1" x 5 yd / Dual Lock(TM) Re-closable

3M MASKING TAPE

General purpose paper tape. Note: When used on a smooth surface it may leave adhesive residue when removed.



Part Number	Size
3MT12	1/2" x 60 yd
3MT34	3/4" x 60 yd
3MT1	1" x 60 yd
3MT112	1 1/2" x 60 yd
3MT2	2" x 60 yd

3M TEMFLEX 1700 VINYL ELECTRICAL TAPE

Economical and durable general purpose insulating tape. UL listed for 176° F / 80° C. 7 mil thick.



Part Number	Size
3M1700	3/4" x 60'

3M SUPER 33+ VINYL ELECTRICAL TAPE

Premium grade 7 mil tape that applies well at 18° C / 0° F and has an operating range up to 105° C / 220° F. Flame retardant. Hot and cold weather resistant. Resists UV rays, abrasion and acids



Part Number	Size
3MS33	3/4" x 66'

3M SUPER 88 VINYL ELECTRICAL TAPE

Heavy duty version of Super 33+ tape. 8.5 mil thickness provides added electrical properties, quicker insulation buildup and abrasion resistance. Superior cold weather handling. Operating range -18° C / 0° F to 105° C / 220° F



Part Number	Size
3MS88	3/4" x 66'

3M DOUBLE STICK MOUNTING TAPE

Suitable for interior or exterior use. Resists solvents, weather, and UV rays. Conforms, cushions, and flexes well.



Part Number	Size
3M4026-36	3/4" x 36 yd.

MANY OTHER 3M PRODUCTS AVAILABLE UPON REQUEST

SHRINK TUBING

Heat shrinkable, flexible Polyolefin tubing. Shrinks to half of original size.

*** EPS TYPE IS BLACK DUAL WALL SHRINK TUBE**



Part Number	Size	Length
SHT1	1/8"	4'
SHT2	3/16"	4'
SHT3	1/4"	4'
SHT4	1/2"	4'
SHT5	3/4"	4'
SHT7	1"	4'
SHT1-100	1/8"	100'
SHT2-100	3/16"	100'
SHT3-100	1/4"	100'
SHT4-100	1/2"	100'
SHT6-100	3/8"	100'
SHT5-50	3/4"	50'
SHT7-50	1"	50'
* EPS1	3/16"	4'
* EPS2	1/4"	4'
* EPS3	3/8"	4'
* EPS4	1/2"	4'
* EPS5	3/4"	4'
* EPS6	1/8"	4'

3M SPLICING COMPOUND

(Rubber Tape) This tape is designed for use in splicing and terminating. Once applied the rubber fuses into one piece forming an effective moisture proof connection. Also available in easy to use



Part Number	Size
2242	3/4" x 15'
06149	2 1/2" x 2 1/2" (Box of 25 pads)

3M DUCT TAPE

Made with durable poly-cotton cloth construction. High tack adhesive. 2" x 60 yards.



Part Number	Color
DTS1	Silver
DTB2	Black

5-WAY PENETRANT

Multi-purpose, extremely effective. demoisurant, displaces and dries out electrical apparatus, prevents shorting and increases conductivity. Prevents rust and frees frozen parts.



SILICONE LUBRICANT

Best quality lubricant and protection. Safe on rubber, plastic, leather & paint.



SUPER 77 SPRAY ADHESIVE

Excellent all purpose adhesive. Twice the coverage of other brands.



SKOTCHKOTE ELECTRONIC SEALER

Provides a tough moisture and oil resistant outer seal. Easy to use brush applicator.



Part Number	Description	Size
4608	3M 5-WAY PENETRANT	24 oz
3MSL	3M SILICONE LUBRICANT	24 oz
3M77	3M SUPER 77 SPRAY ADHESIVE	23.5 oz
14853	3M SKOTCHKOTE ELECTRONIC SEALER	15 oz

HAINES SPRAY ADHESIVE

A high strength contact adhesive for bonding a wide variety of materials. Adjustable nozzle. The same as VS185.



Part Number	Size
HP8030	16 oz

BATTERY CLEANER & PROTECTANT



Part Number	Size	Description
BA1900	16 oz.	Cleans corrosion from battery terminals
BA1901	16 oz.	Protects terminals from corrosion

SILICONE SEALANT

Useful for repair and maintenance applications. Remains flexible with excellent resistance to weather, temperature extremes and aging. Fits 1/10 gallon cartridge.



Part Number	Color
RTV1	Clear
RTV2	Black

HAINES - CYANOACRYLATE GLUE



Part Number	Description
KR-A20	2oz ACCELERATOR
KR-D20	2oz DEBONDER
KR-S120	2oz - 3 SECOND - THIN
KR-S220	2oz - 15 SECOND - MEDIUM
KR-320	2oz - 45 SECOND - THICK

ENVI-RO-TECH MINUS 96 FREEZER

A rapidly evaporating liquid that chills to -96° F. Leaves no residue. Used to trouble shoot electronic components and solder joints. Also used to protect heat sensitive components during soldering. No CFCs.



Part Number	Size
1672-10S	10 oz

ENVI-RO-TECH ELECTRONIC CLEANER

Fast acting and highly effective cleaner. No CFCs. Zero residue. Safe on electronic equipment. Used to remove oils, greases, dirt, silicone, and fluxes.



Part Number	Size
1630-16S	12 oz

BUTYL RUBBER

Use to plug, stick, or seal. No shop should be without it.



Part Number	Size
RB15	3/8" x 15'

IF YOU ARE LOOKING FOR SOMETHING SPECIAL CALL HAINES AND LET US KNOW. ALSO CHECK OUR WEBSITE FOR THE LATEST PRODUCT INFORMATION

ELECTRICAL TAPE

We tested 14 different electrical tapes under extreme hot and cold temperatures before we put our name on this one. UL listed for 176° F / 80° C. 7 mil thick.



Part Number	Size
ET14	3/4" x 60Yds.

DOUBLE STICK TAPE.

An excellent quality, economical alternative to 3M double stick tape.

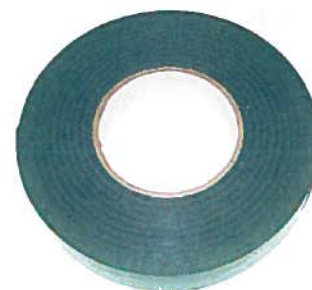

Part Number	Size
4416-24/1	1" x 24 yds.

GLUE STICKS

Available in black or clear.



Part Number	Color	Length
GSC	Clear	4"
GSB10	Black	10"

HIGH STRENGTH GLUE STICKS

These high resin glue sticks outperform all other brands so well that no glue stick comes close. Exceptionally high strength allows use wherever you ordinarily would not use a glue gun.



Part Number	Color	Length
HDG5	White	8"

HAINES BLACK HOOK & LOOP MADE BY VELCRO

Quality and economy. Strong adhesive. Super price!

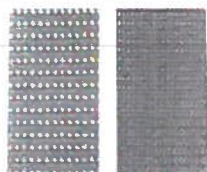

Part Number	Size Type
VCO1L	1" Loop
VCO1H	1" Hook
VCO2L	2" Loop
VCO2H	2" Hook

SOLDER

60/40 Rosin Core. .040 diameter.



Part Number	Size
S1	3 meters
SR40	1 lb

INDUSTRIAL GLUE GUN

High output, uses three solid state heaters. Melts twice the amount of standard glue guns.



Part Number	Description
AG900	Glue Gun

SOLDERING IRON

- Fast Heat
- Light Weight
- Long Service
- Easy Operating

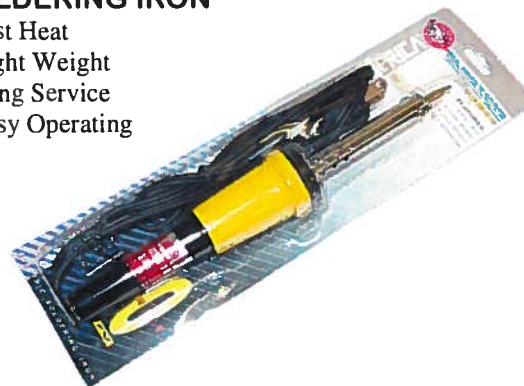

Part Number	Watts
SI74B55	30

RATCHET CRIMPERS

Available for coax cable or insulated terminals.



Part Number	Description
RIC	Insulated Terminals
RCC	Coax Connectors

WIRE STRIPPERS

Sold with or without spring.
Strips 12-24 gauge wires.



Part Number	Description
WS1	No Spring
WS2	With Spring

EZ STRIPPER

Adjustable. Heavy duty version



Part Number	Description
SC2	Strips AWG 10-26 Wires

IGNITION TOOL

Cuts & strips 7 mm and 8 mm ignition wire
Also crimps ignition terminals with (W) & (F) crimp.

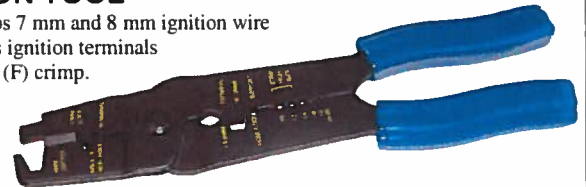

Part Number	Description
M9	Wire Range AWG 22-10

STRIPPER CRIMPER

Quality tool with 5 different sized BOLT CUTTERS Crimps insulated, un-insulated and ignition terminals



Part Number	Description
M5	Wire Range AWG 22-10

DELUXE STRIPPER CRIMPER

The finest tool of its type.
Super sharp stripper and cutter. Well balanced.



Part Number	Description
M20	Wire Range AWG 22-10

HEAVY DUTY STRIPPER CRIMPER

Excellent tool with solid hardened center pin

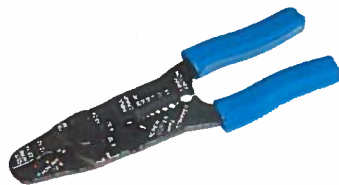

Part Number	Description
M7	Wire Range AWG 22-10

RAZOR BLADES



Part Number
RB100

UTILITY BLADES WITH DISPENSER

Contains 100 blades. Dispenser hangs on wall.



Part Number
RB44102

HAND TOOL KIT - BOJO



Part Number	Gauge
BO-ATHMNGL	7 PIECE MASTER INSTALLER KIT
BO-ATHKNGL	4 PC COMBINATION KIT
BO-ATH-1-NGL	Tool- Single

SPECIFICATIONS

Length w/cap	254 mm (10 in)
Length w/Soldering tip	245 mm (9.7 in)
Weight (when gas -filled)	166 g
Approximate temperature Soldering tip	250-550° C (480-1000° F)
Torch	1300°C (2500°F)
Gas container capacity	38 ml.
Operating capacity (one gas filling)	200 min. At mid setting



APPLICATIONS

- Automotive and truck repairs
- Aviation service and repair
- Electrical components
- Environmental splicing
- Infield repairs
- Jewelry repair
- Shrink tubing
- Solder circuit boards
- Loosen rusted nuts
- And many more

Part Number

PRO-120

SPECIFICATIONS

Out body M'Ment:	(H) 115mm (W) 80mm (L) 25mm
weight	95g
fuel	CF-30C Refill
Hours of nonstop burning	Approx 20 min. (per disposable)
Temp	650°C / 1300°F



APPLICATIONS

- General heating and drying applications
- PVC bending
- Preheat Flux
- Shrink and terminate heat shrinkable insulated solder performs
- Stretch vinyl's
- Vinyl repair
- thawing frozen locks
- And many more

Part Number

MJ-600

CF-30C Fuel Cell

AUTOMATIC IGNITION HEAVY-DUTY MULTI-FUNCTION HEAT TOOL. POWERED BY LEC™ (LIQUID ENERGY CELL)TECHNOLOGY.



SPECIFICATIONS

- 30W - 185W Range
- Soldering Iron and Torch Functions
- Soft Touch Grip
- Removable LEC Contains power for 120 minutes of use. Rechargeable LEC from Standard Butane Fuel available anywhere.

Part Number

PRO-180

Liquid Energy Cell

Automotive Silver Bearing Solder Paste FAST and EASY to apply with Match, Lighter, Soldering Iron or Torch.

- Five times stronger than ordinary solder, tensile strength: 10,000 to 25000 PSI.
- Flows freely and smoothly at 430° F
- Provides strength without distortion of the high temperture brazing.
- Solders most metals
- Better electrical conductivity, stress and vibration resistant.



Part Number

SP-7

CRIMPING TOOL

For non-insulated terminals. Crimps 10-22 gauge wire connectors. One handle red, one handle black.



Part Number	Size
K1006	9 3/4"

CRIMPING TOOL

For insulated and non-insulated terminals. Crimps 10-22 gauge wire connectors. Wire cutter in nose. Red handles.



Part Number	Size
K1005	9 3/4"

LONG NOSE ALL-PURPOSE TOOL

For insulated and non-insulated terminals. Crimps 10-22 gauge wire connectors.



Part Number	Size
K1010	8"

MULTI PURPOSE WIRE STRIPPER/CUTTER

Strips 10-20 gauge wire. Scissors action for clean cuts. Serrated jaws bend, shape or pull wire.



Part Number	Size
K1011	6"

WIRE STRIPPER / CUTTER

Strips 12-26 gauge wire.



Part Number	Description
K1004	with Spring
K1003	no Spring

DIAGONAL-CUTTING PLIERS

Full-flush cutting



Part Number	Size
KD275-5	5"

STANDARD LONG NOSE PLIERS

With coil spring. Knurled jaws.



Part Number	Size
KD301-5C	5 9/16"

HIGH LEVERAGE DIAGONAL CUTTERS

36% greater mechanical cutting advantage over ordinary diagonal cutters.



Part Number	Size
KD228-8	8"

MIDGET SLIM NOSE PLIERS

Small and light weight. Use for precision work. With coil spring.



Part Number	Size
KD321-4C	4 3/4"

AUTOMATIC WIRE STRIPPER

For 10-22 AWG Wire



Part Number
K11062

RETRACTABLE UTILITY KNIFE

Three cutting positions. Blades load through front eliminating the need to disassemble. Drop down storage for blades.



Part Number
K44105

FOLDING HEX SET

Tough heat-treated chrome nickel alloy steel. Square cut for maximum contact.



Part Number	Key Lengths
K70591	Standard (1 3/4" to 3 1/2")
K70582	Metric (41 to 76 mm)

SCRATCH AWL

Steel blade with husky steel handle. Point heat treated for long life.



Part Number
K66385

RATCHETING SCREWDRIVER SET

Three position ratcheting system. Bits store inside handle. Includes #1 and #2 Phillips and two slotted bits.



Part Number
K32473

UNIBIT DRILL BITS

Perfect for drilling multiple size holes in metal, plastic, and wood. Rugged high speed steel. Diameter markings for easy hole size identification.



Part Number	Size	Drill Size
K59001	1/8" to 1/2"	1/4" and up
K59002	9/16" to 1"	1/2" and up
K59003	1/4" to 3/4"	3/8" and up
K59004	13/16" to 1 3/8"	1/2" and up
K59005	3/16" to 1/2"	1/4" and up
K59014	3/16" to 7/8"	1/4" and up

REGULAR POINT HIGH SPEED DRILL BITS



Part Number	Size
K53104	1/8"

IF YOU ARE LOOKING FOR SOMETHING SPECIAL CALL HAINES AND LET US KNOW. ALSO CHECK OUR WEBSITE FOR THE LATEST PRODUCT INFORMATION

TAMPER RESISTANT TORX BIT SET

Kit includes seven 1/4" hex insert bits. Tamper resistant Torx fasteners are found on radio mountings, exterior mirrors, etc. Includes vinyl holder. Bits are also sold separately.



Part Number	Size
L26000	T-10 thru T-40

SCREWDRIVER BITS

1/4" hex shank. Made of heat treated alloy steel.



Part Number	Size
L25410	#1 Phillips
L25420	#2 Phillips

TERMINAL TOOLS

Remove wires from terminals without damaging either. L56500 prongs depress the "barbs" on conventional terminals. L14900 is designed for pack-con and weather-pack terminals on GMC3 systems.



Part Number
L14900
L56500

TELESCOPING MAGNETIC PICKUP TOOL

Magnet shielded to concentrate magnetic field at end of tool. Super strong magnet. 4 1/2" to 16 1/4".



Part Number
L66500

RAZOR BLADE SCRAPER

Designed to reach in tight places. Includes five steel blades and one plastic blade for laminated windshields. Store blades in handle.



Part Number
L52000

WINDOW & DOOR CLIP TOOL

Removes and installs door handle and window crank clips. Works on GM, Ford, and others using common "C" type clip. Prevents damage to door panel upholstery.



Part Number
L18600

DOOR HANDLE REMOVER

For plastic fasteners. Rugged tool with large comfortable handle.



Part Number
L35350

DOOR UPHOLSTERY REMOVER

For plastic fasteners. Rugged tool with large comfortable handle.



Part Number
L35400

FUSE PULLER

No more stuck or broken fuses.
Works on glass and blade fuses.



Part Number

L55200

HEAVY DUTY CIRCUIT TESTER

Probe, handle, cord, and clamp are reinforced
for durability. Up to 20 volts.



Part Number

L26270(Replacement Bulb)

L28400

**IF YOU ARE
LOOKING FOR
SOMETHING
SPECIAL CALL
HAINES AND LET US
KNOW. ALSO CHECK
OUR WEBSITE FOR
THE LATEST
PRODUCT
INFORMATION**

LOW VOLTAGE CIRCUIT TESTER

Quick check for AC or DC currents up to 20 volts.
Insulated grounding clip.



Part Number

L26250

"HANDY HOOKER" CIRCUIT TESTER

Hooded probe protects your fingers and
automatically centers wire. Up to 20 volts.
Insulated grounding clip.



Part Number

L25600

COMPUTER SAFE CIRCUIT AND POLARITY TESTER

Will not damage sensitive electronic components.
Draws less than 21 mA. Red glow indicates
positive polarity. Green indicates negative.



Part Number

L24550

STORAGE BOXES

Metal boxes with plastic scoop compartment inserts.



Part Number	Compartments	Size
20C	20	18" x 12" x 3"
21C	21	18" x 12" x 3"
20S	20	13 3/8" x 9 1/4" x 2"
21S	21	13 3/8" x 9 1/4" x 2"

STORAGE BOXES Plastic

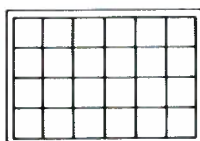

Model SP-24

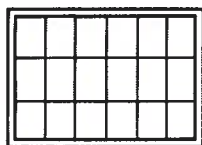

Model SP-18

Part Number	Compartments	Size
SP-18	18	11" x 6 3/4" x 1 3/4"
SP-24	24	13 1/8" x 9" x 2 5/16"

STORAGE BOX RACKS

Holds four storage boxes.



Part Number	Size
4LR	Fits Large Boxes (20C + 21 C)
4SR	Fits Small Boxes (20S + 21S)

STORAGE BOX RACK BASE



Part Number	Size
BLR	Fits Large Racks (20C + 21 C)
BSR	Fits Small Racks (20S + 21S)

WIRE RACK

All steel construction.
Four steel rods.
Store and dispense.

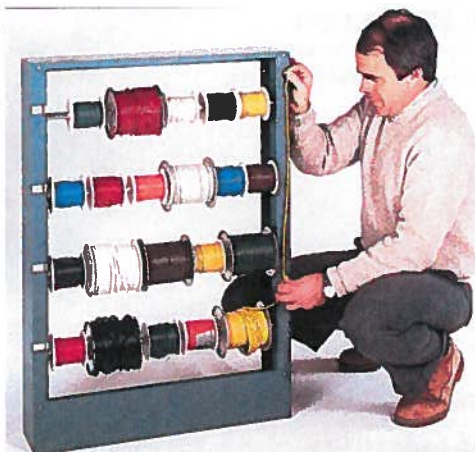

Part Number
WSR4

FLUORESCENT WORK LIGHT

20' cord.



Part Number	Description
SL676	Work Light
SL103	Replacement Bulb

WORK LIGHT 20' CORD



Part Number	Description
SL421	Work Light

FLUORESCENT WORK LIGHT ON RETRACTABLE REEL

20' cord.



Part Number	Description
SL651	Work Light
SL103	Replacement Bulb

EXTENSION CORD ON REEL QUAD TAP - 16/3 10 Amp
CB



Part Number
BAY-SL755

WORK LIGHT - FLUORESCENT RETRACTABLE REEL -
40'

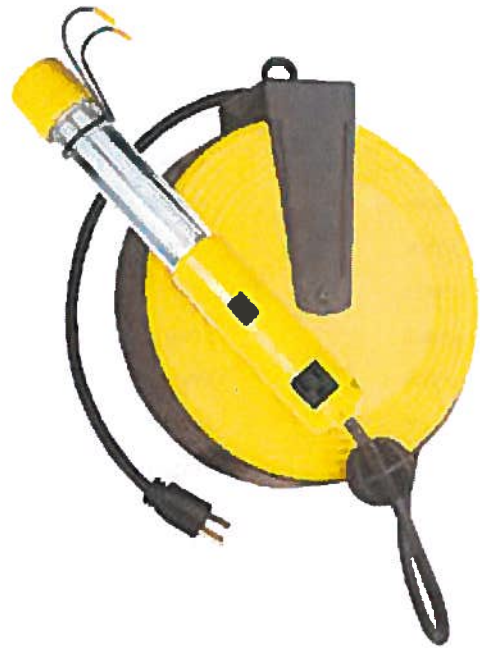

Part Number
BAY-SL825

WORKLIGHT LED PRO - 66 EMITTERS - RECHARGE-
ABLE



Part Number
BAY-SLR2266

WORKLIGHT LED PRO - 36 EMITTERS - RECHARGE-
ABLE



Part Number
BAY-SLR2236

RETRACTABLE REEL - 18/3SVT FOR WORK LIGHT -
30FT - UL



Part Number
BAY-SL800

MINI ATC BLADE FUSES



Part Number Domestic	Part Number Import	Amperage
ATM1	ATYM1	1
ATM2	ATYM2	2
ATM3	ATYM3	3
ATM4	ATYM4	4
ATM5	ATYM5	5
ATM7.5	ATYM7.5	7.5
ATM10	ATYM10	10
ATM15	ATYM15	15
ATM20	ATYM20	20
ATM25	ATYM25	25
ATM30	ATYM30	30

ATC BLADE FUSES

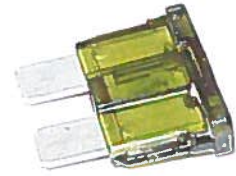

Part Number Domestic	Part Number Import	Amperage
ATC1	ATY1	1
ATC2	ATY2	2
ATC3	ATY3	3
ATC4	ATY4	4
ATC5	ATY5	5
ATC7.5	ATY7.5	7.5
ATC10	ATY10	10
ATC15	ATY15	15
ATC20	ATY20	20
ATC25	ATY25	25
ATC30	ATY30	30
ATC40	ATY40	40

MAXI ATC BLADE FUSES



Part Number Domestic	Part Number Import	Amperage
MATC20	MATY20	20
MATC30	MATY30	30
MATC40	MATY40	40
MATC50	MATY50	50
MATC60	MATY60	60
	MATY70	70
	MATY80	80
	MATY100	100

LOW PROFILE BLADE FUSE



Part Number Domestic	Part Number Import	Amperage
ATLM-10	ATLY10	10
ATLM-15	ATLY15	15
ATLM-20	ATLY20	20
ATLM-25	ATLY25	25
ATLM-30	ATLY30	30
ATLM-5	ATLY5	5
ATLM-7.5	ATLY7.5	7.5

ATC BLADE FUSE LED GLOW



Part Number	Amperage
ATO20-LED	20
ATO25-LED	25
ATO30-LED	30
ATO35-LED	35
ATO3-LED	3
ATO5-LED	5
ATO7.5-LED	7.5

IF YOU ARE LOOKING FOR SOMETHING SPECIAL CALL HAINES AND LET US KNOW. ALSO CHECK OUR WEBSITE FOR THE LATEST PRODUCT INFORMATION

FUSE BLOCK EXTENSION

An Innovative add-a-circuit, two-slot fuse plug that provides a wire lead for splicing portable electronic devices (up to 10 amps) into the fuse block. One slot accepts the original vehicle fuse; the other accepts the fuse for a phone, fax, radio, etc., eliminating the need for an additional fuse holder. The fuse plug is available for mini-ATM and ATC fuse.

Features

- Turns one fuse into two, Plugs into occupied or vacant slot.
- Provides one fuse holder to protect existing circuit, and a second fuse holder to protect the new circuit.
- 10-Amp rating at 12 volts 16-gauge lead for new circuit is 5" long and includes an insulated crimp-type coupler.



Part Number	Description
ATM Plug	For ATM fuse
ATC Plug	For ATC fuse

MAXI FUSEHOLDER with Cap



Part Number	Size
MWP2	8 Gauge

ATC FUSEHOLDER

Waterproof Cap.
Black Body with Red Wires.



Part Number	Size
BFH18	18 Gauge
BFH16	16 Gauge
BFH14	14 Gauge
BFH12	12 Gauge
BFH10	10 Gauge
BFH10-Clear Red	10 Gauge
BFH8-Clear Red	8Gauge

ATC FUSE PANEL

Ideal for adding extra circuits.
160 amp rating for all branches / 30 per branch.
Quick connect terminals.



Part Number	Positions
FP6	6
FP8	8
FP10	10

ATM FUSEHOLDER

Waterproof Cap. Black Body with orange Wires.

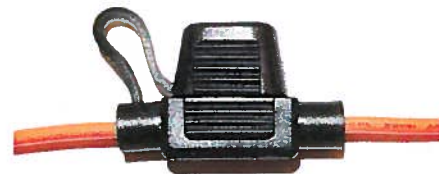

Part Number
BFH/MINI16



GLASS FUSE & HOLDERS



AGC FUSES

1/4" x 1 1/4" Quick acting fuses for electronic applications.



Part Number	Amperage
AGC1	1
AGC1.5	1.5
AGC2	2
AGC3	3
AGC4	4
AGC5	5
AGC7.5	7.5
AGC10	10
AGC20	20
AGC25	25
AGC30	30
AGC35	35
AGC40	40

GMA FUSES

Miniature quick acting fuse. 250V 20 mm x 5 mm.



Part Number	Amperage
GMA0.5	0.5
GMA1.5	1.5
GMA2	2
GMA3	3
GMA4	4
GMA5	5
GMA6	6
GMA8	8
GMA10	10
GMA15	15

AGU FUSES GOLD AND STANDARD

13/32" x 1 1/2" Heavy duty fuse for high current applications.

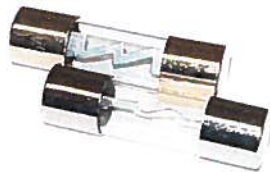

Part Number	Amperage
AGU10	10
AGU20	20
AGU30	30
AGU40	40
AGU50	50
AGU60	60
AGU70	70
AGU80	80
GAGU10	10
GAGU20	20
GAGU30	30
GAGU40	40
GAGU50	50
GAGU60	60
GAGU70	70
GAGU80	80

BAKELITE AGC / AGU FUSEHOLDER



Part Number	Size
BGH16	16 Gauge
BGH14	14 Gauge
BGH12	12 Gauge
BGH10	10 Gauge
HAH8	8 Gauge

IN-LINE AGC PLASTIC FUSEHOLDER



Part Number	Size
FH18	18 Gauge
FH16	16 Gauge

WATERPROOF IN-LINE AGC FUSEHOLDER

Ideal for harsh environments. Simple crimp assembly.
Accepts 18 g to 12 g wire. 30 amp rating.



Part Number

HFB

UNIVERSAL AGC IN-LINE FUSEHOLDER

Simple crimp assembly. Accepts 18 g to 12 g wire.
30 amp rating.



Part Number

HHB

GLASS FUSE TAPS

Clip onto the existing fuses to provide additional connection point for quick disconnect terminals.



Part Number

GFT

Size

AGC Fuse Tap

GOLD ANL FUSES

Beautiful gold plating.



Part Number

Amperage

ANL80A

80

ANL100A

100

ANL150A

150

ANL200A

200

ANL250A

250

ANL300A

300

GBC BAKELITE FUSES

European Type Fuse.



Part Number

Amperage

GBC5

5

GBC8

8

GBC16

16

GBC25

25

HIGH POWER MANUAL CIRCUIT BREAKER

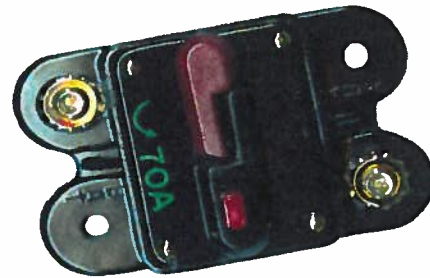

Part Number

Amperage

HCB100

100

HCB140

140

HCB200

200

BLADE FUSE TAPS - Clip onto the existing fuses to provide additional connection point for quick disconnect terminals.

BFT2

BFT1

MFT



Part Number

Type

MFT

ATM Fuse Tap

MFT2

ATM Fuse Tap W / Slide Hole

BFT1

ATC Fuse Tap

BFT2

ATC Fuse Tap

STANDARD ATC BLADE FUSE TAPS

Sold with connector. 100 taps and 100 disconnects per kit.



Fuse sold Separately

Part Number

Wire Range

BFN-KIT

16-14

MINI BLADE FUSE TAPS

Sold with special connector. 100 taps and 100 disconnects per kit.

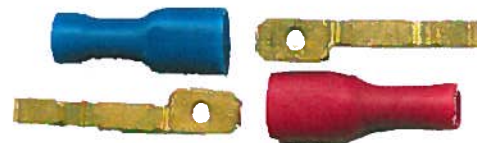

Part Number

Wire Range AWG Color

RT-KIT

22-18 Red

BT-KIT

16-14 Blue

ROUND LED ROCKER SWITCH

12 VOLT / 15 AMP MOUNTING HOLE 3/4"



Part Number	Color
RKR4B	Blue
RKR4G	Green
RKR4R	Red

SQUARE PUSH BUTTON SWITCH ON / OFF TYPE



Part Number	Color
R18-23A BLK	Black
R18-23A GRN	Green
R18-23A RED	Red

DOOR PANEL FASTENERS

Sold in 10 packs GM/FORD Type



Part Number
HA90

TAP CAPS

Fits all #2 Phillips and Pozidrive heads. Great for drywall and super sharp screws. Colors: Black, Gray, Red, Tan, and White.



Part Number
TAP + COLOR

CAMOUFLAGE SCREW CAPS

Colors: Black, Brown, Light Gray, Dark Gray, Light Blue, Dark Blue, Red, Dark Red, White, Off-White and Tan.



Part Number
CSK + COLOR

METAL BACK STRAPS



Part Number	Size
MBS9	9"
MBS13	13"
MBS18	18"

ILLUMINATED TOGGLE SWITCH

SPST on-off. Illuminated handle. 16 amps at 12 volts.



Part Number	Color
LTA	Amber
LTB	Blue
LTG	Green
LTR	Red

MOMENTARY MINI-ROCKER SWITCH

SPDT mom-off-mom. Center position off. Great for door locks. Made in U.S.A.



Part Number
RKR2

MINI ROCKER SWITCH

SPST on-off. Made in U.S.A.



Part Number
RKR3

TOGGLE SWITCH

SPST toggle switch prewired with 24" leads. 3 amp 125 VAC.



Part Number
SSW265

HEAVY DUTY TOGGLE SWITCH

Prewired with 6" leads. 15 amp at 12 volt.



Part Number
DS184

VALET SWITCH

Momentary, normally open, push button switch with 25" leads.



Part Number
SSW260

IF YOU ARE LOOKING FOR SOMETHING SPECIAL CALL HAINES AND LET US KNOW. ALSO CHECK OUR WEBSITE FOR THE LATEST PRODUCT INFORMATION

RCA PATCH CORDS

OFX SERIES 24 KT. GOLD PLATING RCA PATCH CORDS

Oxygen free. Clear, flexible jacket.
Finely braided copper shield.
20 gauge stranded conductor.
Unbelievable performance for the price!



Part Number	Length
OFX1	1'
OFX3	3'
OFX6	6'
OFX12	12'
OFX17	17'
OFX25	25'

24 KT GOLD PLATED PATCH CORDS

Gold plated for low loss.
High density shielding.
Strain reliefs for greater durability.



Part Number	Length
HCA01	1'
HCA03	3'
HCA06	6'
HCA12	12'
HCA17	17'
HCA20	20'

OFX SERIES GOLD "Y" CONNECTORS

"Y" Connectors in our OFX style
for premium performance



Part Number	Description
OFX2F	1 Male to 2 Female
OFX2M	2 Male to 1 Female

RCA "Y" CONNECTORS

Choice of Nickel or 24 kt.
gold plating.



Part Number	Description
Y2F	1 Male to 2 Female/Gold
Y2M	2 Male to 1 Female/Gold

RCA SPLICES

Low loss splices in 24 kt.
gold or nickel plating.



Part Number	Description
105B	Black Nickel Female
105R	Red Nickel Female
106B	Black Nickel Male
106R	Red Nickel Male
HRS5B	Black Gold Female
HRS5R	Red Gold Female
HRS7B	Black Gold Male
HRS7R	Red Gold Male

GOLD RCA RIGHT ANGLE PLUGS

24 kt. gold plating. Sold in pairs, one black, one red.



Part Number	Description
RPSB	Black Gold Short
RPSR	Red Gold Short
RPLB	Black Gold Long
RPLR	Red Gold Long

GOLD DUAL BANANA PLUG

24 kt. gold plated.
Two pole plugs with set screw
for securing speaker wires.

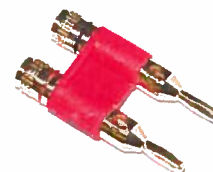

Part Number
BP22



CAR AUDIO POWER CELLS



Kinetik HC Power Cells are used in the "Worlds Loudest Vehicle" providing the power to reach over 180dB and boasts hundreds of competition victories! Due to low ESR and high energy density, Kinetik HC Power Cells are the most powerful, reliable and compact car audio power cells on the market today. Kinetik Power Cells are used by top competitors along with car audio and video enthusiasts alike.

Kinetik HC1200 Power Cell

1200W of support in a small compact design works great in small spaces where more power is needed. Fits many import OEM locations.

Specifications
Weight: 28lbs
Ah: 50
Dimensions:
7.7"x6.5"x6.9"



Common Specifications
AGM Technology
Sealed Non-Spillable Design Mount In Any Position
Ultra Low ESR More Plates For Stronger Energy Density
Higher Voltage Under Load Tightly Packed Cells
Superior Heat & Vibration Resistance

Part Number

KHC1200

Kinetik HC1400 Power Cell

Most powerful cells for Honda or Mitsubishi OE replacement. Thin profile fits many cars. Provides serious current for any demands. Available in reversed terminals to allow for easy installation in many import OEM locations, ask your retailer for KHC1400R.

Specifications
Weight: 39lbs
Ah: 60
Dimensions: 9"x5.3"x8.1"



Common Specifications
AGM Technology
Sealed Non-Spillable Design Mount In Any Position
Ultra Low ESR More Plates For Stronger Energy Density
Higher Voltage Under Load Tightly Packed Cells
Superior Heat & Vibration Resistance

Part Number

KHC1400

Kinetik HC16V Power Cell

With our dual post design for running at 12 volt or 16 volt, this bad boy has what it takes to run your amplifiers and equipment at peak performance. For high end systems, running multiple HC16V Power Cells will give you that edge you need to win.

Specifications
Weight: 54lbs
Ah: 62
Dimensions: 10"x6.5"x8.2"



Common Specifications
AGM Technology
Sealed Non-Spillable Design Mount In Any Position
Ultra Low ESR
More Plates For Stronger Energy Density
Higher Voltage Under Load
Tightly Packed Cells
Superior Heat & Vibration Resistance

Part Number

KHC16V

Kinetik HC600 Power Cell

More powerful than 100 1 farad caps! Extreme power in a small package. Mount near your amplifier for tons of power reinforcement. Easily starts a V8 engine!

Specifications
Weight: 14lbs
Ah: 20
Dimensions: 7"x3"x6.5"



Common Specifications
AGM Technology
Sealed Non-Spillable Design Mount In Any Position
Ultra Low ESR More Plates For Stronger Energy Density
Higher Voltage Under Load
Tightly Packed Cells
Superior Heat & Vibration Resistance

Part Number

KHC600



CARPET



Multiple™ OEM Construction

Automotive trim carpet for cars, vans, trucks and RVs. Plush high-pile surface.
 Random, non-linear pattern won't "grin."
 Durable - stands up to heavy use.
 Solution-dyed polypropylene for good colorfastness.

Resists stains and soiling, molds and mildew.
 Easy to cut, fit, and mold into desired shape or size. Nonwoven carpet will not fray or unravel. 40" wide without latex backing.



AM12
* Black



AM9
* Burgundy



AM10
Scarlet



AM24
Medium Prairie Tan



AM21
Medium Dark Oak



AM23
Medium Neutral



AM20
* Mocha



AM22
Medium Parchment



AM15
Medium Almond



AM13
* Navy



AM1
Medium Blue



AM18
Ocean Blue



AM25
* Medium Dark Pewter



AM26
* Medium Graphite



AM27
Dark Graphite



AM8
* Charcoal



AM7
* Medium Gray



AM16
* Cinder

* AVAILABLE WITH LATEX® FINISH

TRUNKLINER



A20
Black



A23
Heather Charcoal



A21
Charcoal



A93
Silver



TRUNK LINERS & GRILL COVERS



AM13 Navy MULTIPLE™ Unbacked



AM12 Black MULTIPLE™ LATEX® FINISH

TRUNKLINER



A23 Heather Charcoal TRUNKLINER

VINYLS 54" x 36"

Charcoal

Black

White

Maroon

Brown

Tan

Gray

Blue

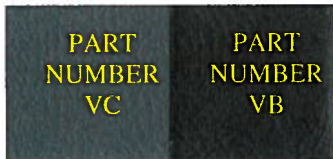

PART NUMBER
VW



GRILL CLOTH 66" x 36"

Blue

Gray

Tan

Brown

Red

White

Black

Charcoal

Maroon





CRIME STOPPER™



SECURITY PLUS™

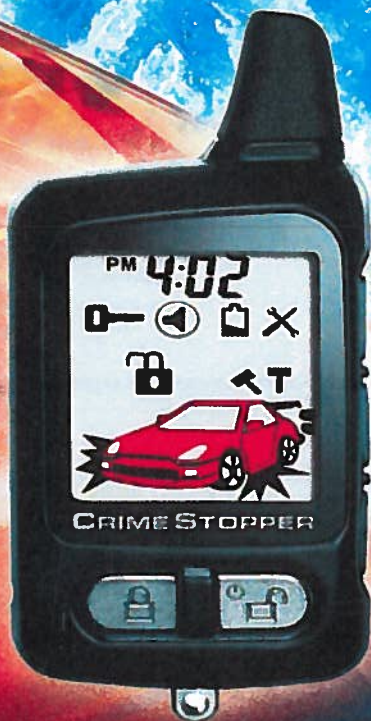
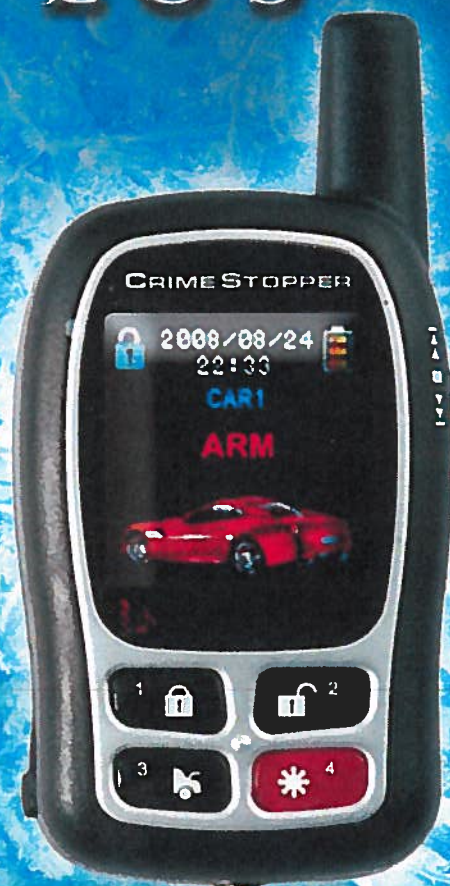
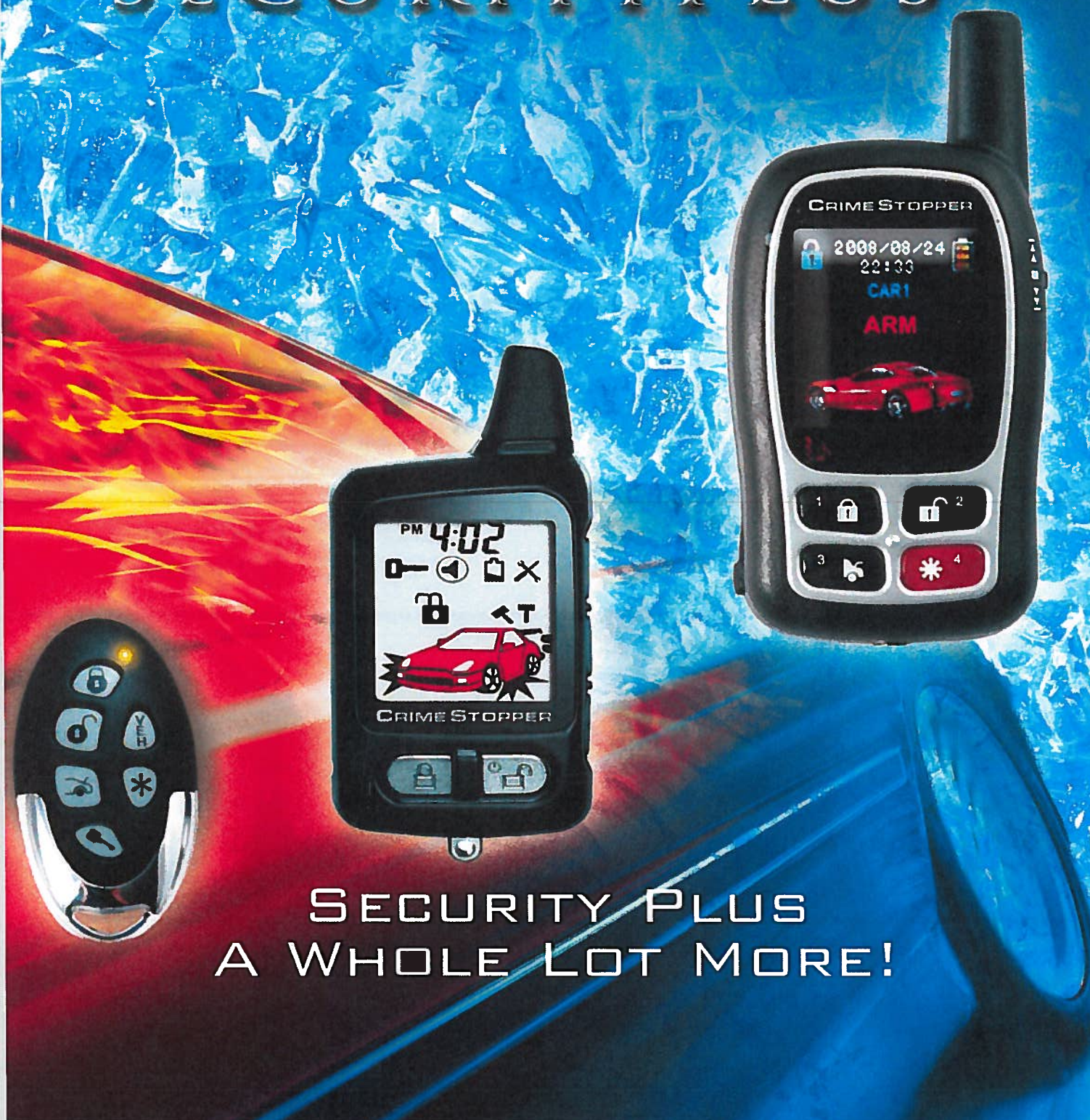

SECURITY PLUS A WHOLE LOT MORE!

2011



SECURITYPLUS™

VEHICLE SECURITY SYSTEMS



P/N CS-SP400

1-Way Combo Alarm and Remote Start System



P/N CS-SP201

Deluxe 1-Way Alarm and Keyless Entry System



P/N - CS-SP101

Deluxe 1-Way Alarm and Keyless Entry System



P/N - CS-870.RKE

Deluxe 1-Way Keyless Entry System



SAFETYPLUS™

CAMERAS / MONITORS / DVR



CRIMESTOPPER SAFETYPLUS™ SECURVIEW

P/N - CS-SV8400RM

Headliner Mount Monitor with 3.5 Inch LCD Screen

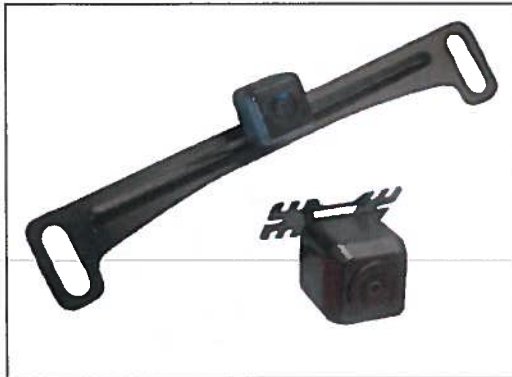

CRIMESTOPPER SAFETYPLUS™ SECURVIEW

P/N - CS-SV5350

170° License Plate / Lip Mount CCD Color Camera with Hidden Mounting Bracket

CRIMESTOPPER SAFETYPLUS™ SECURVIEW

P/N-CS-SV5340

170° License Plate Mount CMOS Color Camera with Hidden Mounting Bracket

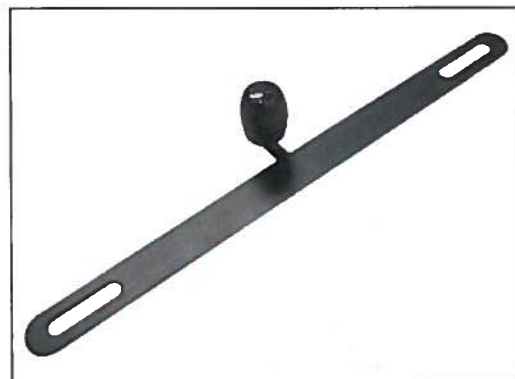

CRIMESTOPPER SAFETYPLUS™ SECURVIEW

P/N - CS-SV5200.IR

180° License Plate Mount CMOS Color Camera with Night Vision



SAFETYPLUS™

CAMERAS / MONITORS / DVR



CRIMESTOPPER SAFETYPLUS™ SECURVIEW

P/N - CS-SV6930LM

180° Lip Mount Style CCD
Color Camera

CRIMESTOPPER SAFETYPLUS™ SECURVIEW

P/N - CS-SV6922.LM

170° Ultra-Small Lip Mount
Style CMOS Color Camera



CRIMESTOPPER SAFETYPLUS™ SECURVIEW

P/N CS-SV-8600-TS

Universal Mount Digital
Touch Screen Monitor with
3.5 Inch LCD Screen

CRIMESTOPPER SAFETYPLUS™ SECURVIEW

P/N - CS-SV-8300-HD

High Definition Digital Color
Universal Mount Monitor with
3.5 Inch LCD Screen





CRIME STOPPER



The Backstopper™ is a rear impact warning sensor system designed to aid the driver when backing up their vehicle. The sensors wide detection angle will alert the driver of any small children, pedestrians, animals or small-unseen objects such as bicycles or parking poles. This makes it very convenient for parking in a parking garage, a crowded lot or even in your own driveway.



P/N CS-CA5010
Reverse Parking Sensor System with Four-Direction LED Display

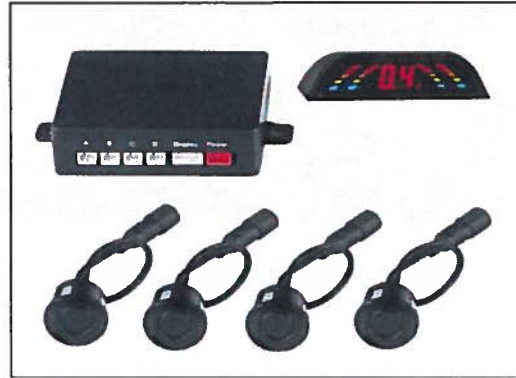

P/N-CS-CA5009
Reverse Parking Sensor System with Audible Buzzer (No LED Display)



P/N - CS-CA5016
Front and Rear Parking Sensor System with Color LED Display

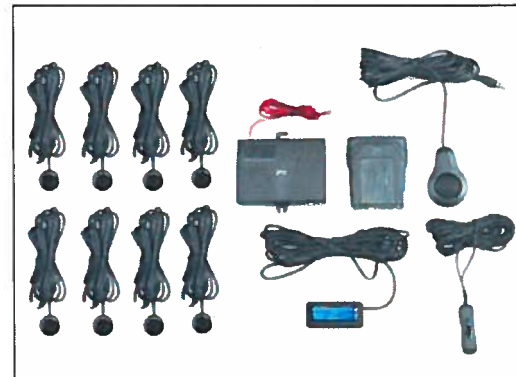

P/N - CS-CA5005U
Reverse Parking Sensor System with Under-Dash Mount LED Display

COOL START™ REMOTE START SYSTEMS



P/N CS-RS4G2

1-Way Remote Start and Keyless Entry System



P/N CS-RS1G2

1-Way Remote Start and Keyless Entry System



P/N - CS-RS7

2-Way Remote Start and Keyless Entry System



CRIME STOPPER



DATABUS ONE WIRE SOLUTION

Part Number	Description
CS-RSTATA.V	OEM TRANSPONDER ANTI THEFT ADAPTER
CS-KEYOVERRIDE.ALL	2-WAY DATA LINK
CS-EVO-ALL	Universal All-In-One Data
CS-EVO-CHR2	EVO-CHR w. #2 T-Harness
CS-CAN.SL-PL	CANBUS DATALINK - 2 WAY
CS-EVO-CHR	2004-2010 ALL-IN-ONE CHRYSLER MODULE
CS-INT.SL	Data Bus interface control
CS-PATSCHR04PL	BYPASS FOR 04+ CHRYSLER
CS-HONDA.SL3	DATALINK - 2WAY HONDA & ACURA
CS-103	GLASS SENSOR
CS-FLASHLINK	FLASHLINK UPDATER
CS-CANSLPL	BYPASS - COVERS ALL CANSL2
CS-TL150	Internet updateable 2 way data port verifier
CS-TB-GM2	GM Transponder Box
CS-EVO-CAN	
CS-PATSMITS2	Key bypass kit - Mitsubishi Includes built-in transponder
CS-INTCHR2	REMOTE STARTER IGNITION INTERFACE 08-09 CHRYSLER
CS-PATS-SUBARU	PATS bypass kit for Subaru
CS-PATS-MIT3	PATS bypass kit for Mitsubishi
CS-PATS-INF.1	PATS bypass kit for Infiniti M35 & M45
CS-PASSLOCK.SL2.H3	Passlock II data bypass kit for Hummer H3
CS-OFA20	Door lock Interface And Transponder Override
CS-INT.BMW1	Remote car starter interface kit for BMW 06-07
CS-HONDASL.CAN	Same as Honda-SL3 PLUS CanBus for Door Locks
CS-GM.TBU	PATS bypass kit for Chrysler, Dodge, Jeep and
CS-GM.TB7	Passkey 3 (PK3) and Passlock I & II bypass kit-Chevy,
CS-GM.PK3	Passkey 3 (PK3) and Passlock data bypass kit for all GM
CS-PASSLOCK.SL2	2-WAY DATA LINK SELF LEARN ALL GM w/PASSLOCK



DELUXE HEAT SEAT KIT



- Quick heat-up time (1-2 Minutes)
- Carbon Fiber backrest and bottom cushion heating pads
- Pads can be trimmed or cut by installer to fit on any standard seat
- Dual temperature control system (Electronic control and Standard bi-metal thermostat)
- Illuminated 2-color switch for high & low temperature settings
- Quick connect / disconnect flexible system (Reduces length of wiring)
- Heating pads are invisible once installed
- Can be wired into remote start systems for automatic turn-on

Part Number

CS-HSK150

The DS-400 is a dual stage / dual adjustment shock sensor. The "warn-away" trigger and the instant full trigger sensitivity levels can be adjusted separately by turning the two adjustment knobs on the top of the sensor

*The DS-400 comes included with the SP-600, FS-60, FS-80 and FS-90 combo systems

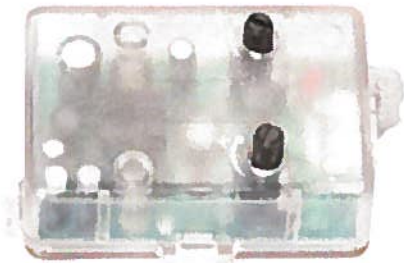

Part Number

CS-DS400

The CS-95.MDFR is a very small motion detection sensor that will help protect your vehicle with an invisible sensing field which detects moving high-density objects (including people) around your car using radio frequency (RF). Ideal for convertibles or any application where zone-intrusion protection is needed. The small design of the sensor allows it to be hidden easily and is quickly adjustable for higher or lower sensitivity
*The CS-95.MDFR is a perfect add-on for convertible vehicles



Part Number

CS-95.MDFR

The CS-103 is a sound-discriminator type audio glass break sensor that detects tampering and breaking of the vehicle's glass using a microphone and microprocessor, which analyzes the frequency, intensity and timing of intrusion sounds to prevent false alarms. Detects even "soft breaks" of the glass which the shock sensor may not pick up.

*The CS-103 is an extra layer of protection which will enhance the security of any Crimestopper alarm or combo system install



Part Number

CS-CS-103

The CS-104.TS.II is a digital tilt sensor that is ideal for protecting your vehicle by detecting when it is being raised by a tow truck or using a jack in an attempt to remove the wheels or tow the vehicle. The CS-104.TS.II auto calibrates each time the alarm is armed, taking into account the vehicle's angle of inclination and ensuring the best and most accurate tilt sensing possible

**The CS-104.TS.II is the perfect solution for protecting vehicles with upgraded rims and tires*



Part Number

CS-104.TSII



SCOSCHE PRODUCTS

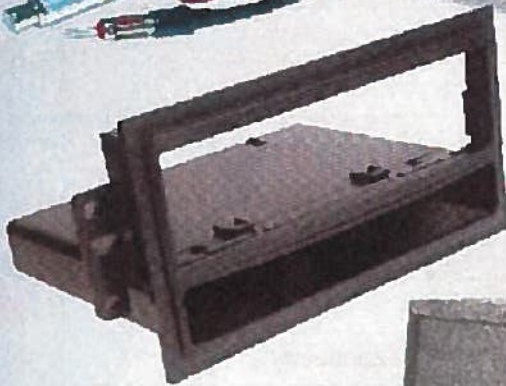
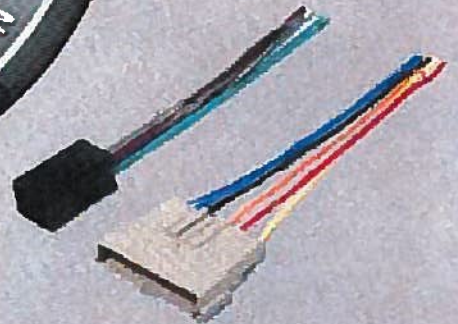
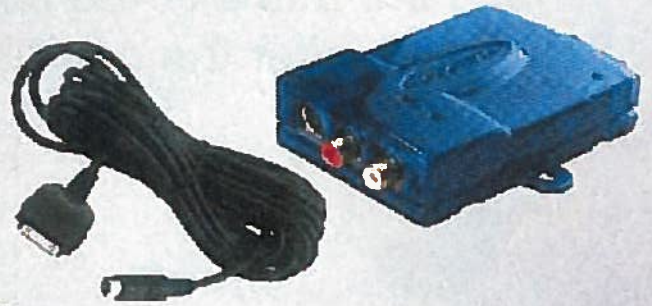

These are a few of the more popular items that we stock, we offer the complete Scosche product line

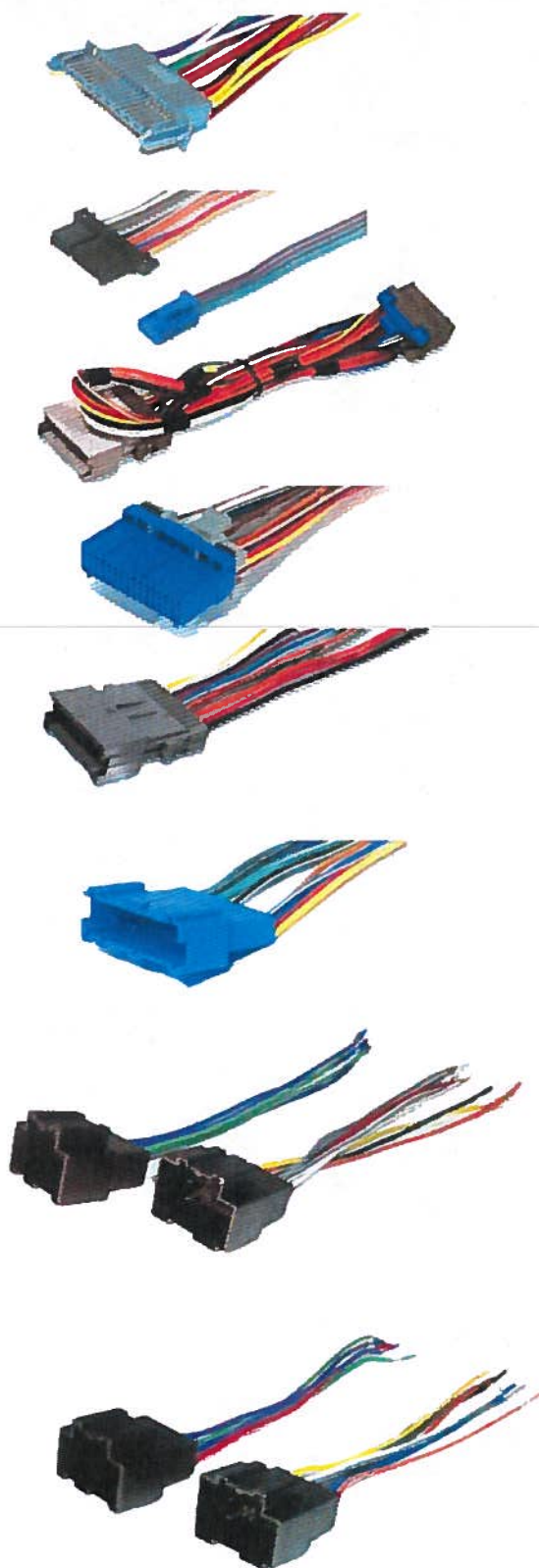

SH-BW01B	BMW Import speaker
SH-CR01B	Chrysler Power/4 Speaker
SH-CR02B	Chrysler/Jeep SPKR
SH-DO01B	Daewoo power / 4 speaker
SH-FD01B	Ford power/4 speaker
SH-FD02B	Ford Power/4 Speaker
SH-FD13B	FORD
SH-FD16B	Ford Power/4 Speaker
SH-FD23B	FORD - MERCURY
SH-FDK10B	Ford/Lincoln/Mercury/Mazda
SH-GM01B	GM Power/4 Speaker
SH-GM02B	GM "Mini" connector
SH-GM03B	GM 32 pin connector
SH-GM05B	Chevrolet
SH-HA01B	Honda power/speaker connector
SH-HA02B	Honda Power/4 Speaker
SH-HA08B	Honda Power/Speaker
SH-HY02B	Hyundai power/4 speaker
SH-HY03B	Hyundai Sonata/Accent spkr
SH-IM01B	Universal Import POWER/SPKR
SH-IU02B	Isuzu/Honda/Acura
SH-JE01B	Jeep/Eagle car stereo
SH-KA01B	Kia speaker connector
SH-KA02B	KIA - 2003 UP
SH-MA02B	Mazda speaker
SH-MA03B	MAZDA VEHICLE HARNESS
SH-MC01B	Mitsubishi/Chrysler speaker
SH-MI02B	Mitsubishi/Dodge speaker
SH-NN02B	Nissan Power/4 Speaker
SH-NN03B	Nissan car stereo connector



SCOSCHE DASH KITS



These are a few of the more popular items that we stock, we offer the complete Scosche product line

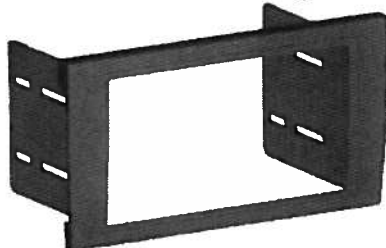
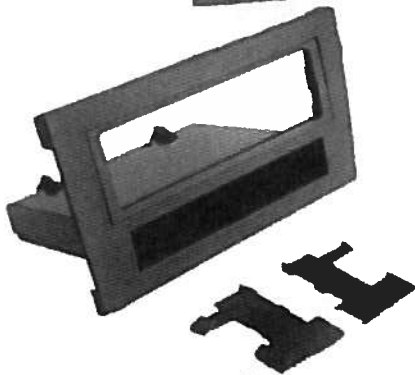
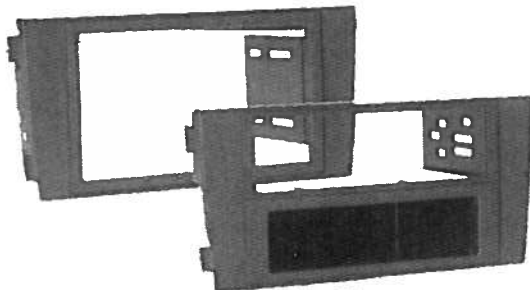
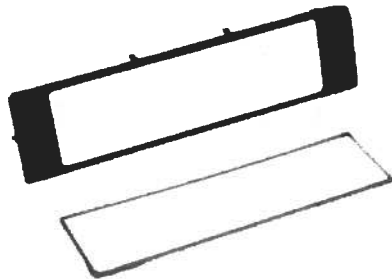
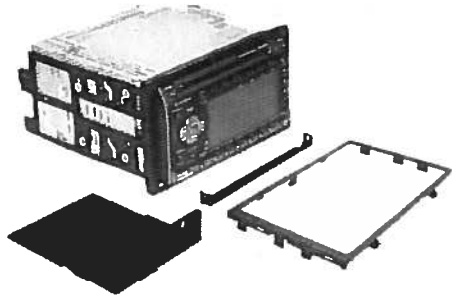

- SK-FD1327B
- SK-CR1277B
- SK-CJ1282B
- SK-HA1563B
- SK-GM1583B
- SK-GM1590AB
- SK-FD1432AB
- SK-FD1422B
- SK-GM1598B
- SK-FD1330B
- SK-GM1483B
- SK-NN1495MTB
- SK-NN1648B
- SK-NN1491B
- SK-MZ2347B
- SK-FD1426B
- SK-CR1286B
- SK-TA1465B
- SK-HY1604B
- SK-GM1599B
- SK-GM1598AB
- SK-GM1587B
- SK-GM1523B
- SK-GM1500B
- SK-FD1438B
- SK-FD1380B
- SK-CR1289B
- SK-CJ1278B
- SK-AU2380B
- SK-AA1568B
- SK-VW2317B
- SK-VO4152B
- SK-TA2076B
- SK-SU2025B
- SK-ST2430B
- SK-SCN2056B
- SK-NN1662B
- SK-NN1498B
- FORD TRUCK/SUV 95 UP
- JEEP G. CHEROKEE 99-04
- CHRYSLER-DODGE-EAGLE 74
- HONDA-ACURA
- GM MULTI MOUNTING KIT
- GM / Hummer / Suzuki / Isuzu
- FORD EXPEDITION 2007
- FORD MUSTANG-EXPLORER
- CHEVY IMPALA-TAHOE
- FORD
- CHEVY 1500 SERIES
- NISSAN SENTRA
- MAXIMA 00-03 DIN & DOUBLE D
- NISSAN FRONTIER-PATHFINDER
- MERCEDES C CLASS
- FORD DOUBLE ISO DIN
- DODGE DURANGO 04 NO NAV
- TOYOTA - TRIM RING
- HYUNDAI Elantra / Sonata
- CHEVY MALIBU
- CHEVY IMPALA-TAHOE
- CHEVY MALIBU
- CADILLAC DTS 06-UP
- GM UNIVERSAL BKTS
- Ford F-150 DIN w/Pocket 2009
- FORD TAURUS
- Chrysler / Dodge / Jeep
- CHRYSLER-DODGE-EAGLE
- AUDI A6
- ACURA RSX - ISO
- VW Jetta / Passat / Golf
- VOLVO S60/S70 - 05-07
- TOYOTA FJ CRUISER
- Subaru Legacy- Outback 05 UP
- Smart for two 2008
- TOYOTA SCION xA, xB, tC
- Nissan Versa 2007 UP
- NISSAN MAXIMA



SCOSCHE ANTENNA ADAPTERS



These are a few of the more popular items that we stock, we offer the complete Scosche product line



SA-MDA1B

ANTENNA ADAPTOR - GM

SA-CRAB

ANTENNA ADAPTER

SA-VWAB

ANTENNA ADAPTER

SA-NDAB

ANTENNA ADAPTER

SAN-WMA

ANTENNA Window Mount



SA-NAA2B

NISSAN - 2007

SA-HAAB

ANTENNA ADAPTER

SA-CRARB

ANTENNA ADAPTER - CHRYSLER

SA-VWA3B

ANTENNA ADAPTER-EURO 02



SA-VWA3RB

ANTENNA ADAPTER - EURO

SA-KAAB

08 SELECT KIA

SA-VWA2B

ANTENNA ADAPTER

SA-NAA2RB

NISSAN 2007 ANTENNA ADAP

SA-MDARB

ANTENNA ADAPTER



SA-VWA4B

ANTENNA TO FACTORY POW-
ERED

SA-MDAB

ANTENNA ADAPTOR

SA-FDAB

ANTENNA ADAPTER

SA-VWARB

VW Reverse Antenna Converter

SA-VOAB

ANTENNA ADAPTER



SA-NDARB

DIVERSITY RADIO TO

SA-FDARB

ANTENNA ADAPTER

SA-SUARB

AFTERMARKET ANTENNA ADAPT

SA-SUAB

ANTENNA ADAPTER

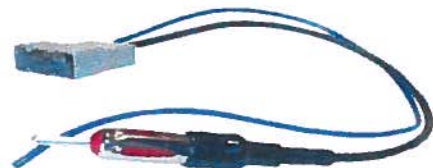

SA-HAARB

AFTERMARKET ANT

SA-VWAKB

ANTENNA KIT - VW

SA-VOARB

ANTENNA ADAPTER -REVERSE

SLC4

4-Channel Speaker Level Converter

- Accepts 80 watts per channel. Can be used as a 4-channel line-out converter to add an amplifier to any existing car stereo or add low level outputs to any car stereo with speaker level outputs only. Can also be used to interface an aftermarket car stereo to either JBL/Premium Sound systems or BOSE audio systems. Transformer circuit for noise cancellation.



- Also is a common ground adapter.



FGAB

Floating Ground Adapter

- Ford/Lincoln/Mercury Common Ground or Premium Sound 5 wire speaker systems.



LOC80

2-Channel Speaker Level Converter

- Accepts head units with 80 watts per channel. Transformer circuit for noise cancellation.
- For use when adding on aftermarket amplifiers to older decks without audio output.

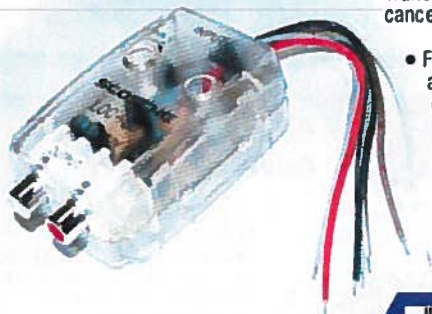

FMMOD02 Audio Modulator

- Allows you to Play your iPod, MP3, CD and DVD through your Car Stereo.
- Power switch Included.
- Installs Easily into your Factory or Aftermarket Car Stereo.
- 87.9 or 88.3 MHz frequency selector



SWC



PART#	DESCRIPTION	UPC
-------	-------------	-----

SWC1	Steering Wheel Radio Control Interface	033991-00864-9
------	--	----------------

- Allows retention of steering wheel or rear seat radio controls when an aftermarket radio is installed Works with most aftermarket radios with wireless infrared remote capability.

- Retains the use of heater control buttons on GM vehicles Covers over 95% of vehicles from 1986-up. Works with most major brand radios and interfaces with most major vehicle manufacturers

SWCJACK	Steering Wheel Control Interface - Alpine/JVC	033991-01446-6
---------	---	----------------

- Compatible directly current 2005 Alpine radios that are Steering remote control ready
- Compatible with Clarion, JVC and Kenwood radios with wired remote inputs

SWCCAN	Steering Wheel Add-on Interface for CANBus	033991-01447-3
--------	--	----------------

- For use when installing SWC1/SWCALP/SWCPS in CAN Bus vehicles.
- Interprets Data from Factory 2-wire CAN Bus steering controls
- Select Chrysler, Dodge, Jeep, Porsche and Mercedes vehicles

SWCPS	Steering Wheel Control Interface - Pioneer/Sony	033991-01448-0
-------	---	----------------

- Compatible with all Pioneer radios which have a steering wheel remote input
- Compatible with Sony radios which works RM-X2S, RM-X3S and RM-X4S wired remote inputs

TODB

Turn On Delay Circuit 0-60 seconds

- A 3 wire circuit that allows the flexibility of delaying a 12 volt turn on wire from 0-60 seconds.



ES034

Ground Loop Isolators

- The ES-034 isolates multiple components to prevent ground loops. It may be used as a trouble-shooting installation tool or to break grounds without removing grounding parts. The ES-034 is designed to interface with line-level outputs and is equipped with two male and female RCA jacks for interconnection with cable adapters/components.



ES004

Single Stage Filters

- Maximum current 10 amperes (100 watts output) for installations including power amplifiers.



US2B

Universal CD Switcher

- Two input, one output, switchable source selector. This is the ideal part when two source units are to be used in your amplified system.



OEA4

Original Equipment Amplifier Adapter

- 4-Channel Car Stereo Speaker Level Converter. Used to adapt aftermarket car stereos to Original Equipment Amplifiers. Will work with most factory amplified systems such as JBL/Premium and BOSE systems.

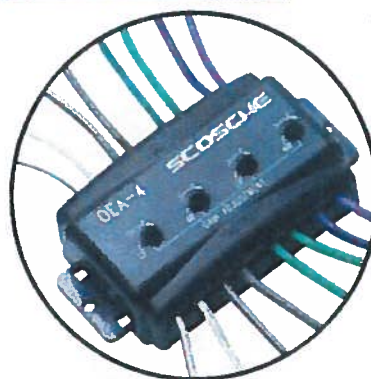

ES014

Antenna Filter

- Reduces static charges picked up by the antenna by providing a ground path to bleed the charge off. It breaks up any ground currents flowing in the antenna wiring to minimize noises being injected from the power system into the antenna. Installation is as easy as unplugging the antenna and inserting this filter inline between the antenna and the radio.



Features

Features	Scosche Loc-80	Scosche SLC-4	Scosche OEA-4
Output in Channels	2	4	4
Low Level Output	Yes	Yes	Yes
High Level Output	No	No	No
Circuit Type	Active	Passive/Active	Passive/Active
Mosfet Capable to 80 Watts	Yes	Yes	Yes
Adjustable Outputs	Yes	Yes	Yes
Interface with Ford/JBL Amplified Systems	No	Yes	Yes
Interface with GM/BOSE Amplified Systems	No	Yes	Yes
Detailed Installation Instructions	Yes	Yes	Yes
Tech Support	Yes	Yes	Yes





- **AMPLIFIER
WIRING KITS**
- **INSTALLATION
ACCESSORIES**

AMPLIFIER WIRING KITS

3200 Watt Dual Amp Kit

E3200

- 17 ft. 15.5mm HEX clear blue power cable
- 8 ft. 9.5mm HEX clear blue power cable
- 6 ft. 9.5mm HEX clear silver ground cables
- 2 - 17 ft. twisted pair HEX audio cables
- 15 ft. 5mm Speaker Wire
- Single ANL fuse holder
- 15.5mm to 9.5mm dual ANL distributor block
- Battery terminal with ABS cover
- Includes all installation hardware



1000 Watt Single Amp Kit

E1000

- 17 ft. 9.5mm HEX clear blue power cable
- 3 ft. 9.5mm HEX clear silver ground cables
- 17 ft. twisted pair HEX audio cables
- 20 ft. 3mm Speaker Wire
- Single ANL fuse holder
- Includes all installation hardware



400 Watt Single Amp Kit

E400

- 17 ft. 6.5mm HEX clear blue power cable
- 6 ft. 6.5mm HEX clear silver ground cables
- 17 ft. twisted pair HEX audio cables
- 20 ft. 3mm Speaker Wire
- Single AGU fuse holder
- Includes all installation hardware



INSTALLATION ACCESSORIES

Power Cable

15.5 mm

- EP155BL-50** Hex blue power wire, 15.5mm, 50 ft.
- EP155C-50** Hex clear power wire, 15.5mm, 50 ft.



9.5 mm

- EP95BL-100** Hex blue power wire, 9.5mm, 100 ft.
- EP95C-100** Hex clear power wire, 9.5mm, 100 ft.



6.5 mm

- EP65BL-200** Hex blue power wire, 6.5mm, 200 ft.
- EP65C-200** Hex clear power wire, 6.5mm, 200 ft.

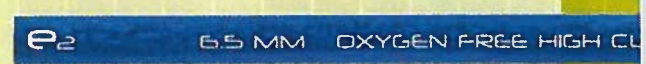

Hex Power Cable



Speaker Wire

- ES5BL-100** Speaker wire, blue 5mm, 100 ft.
- ES3BL-200** Speaker wire, blue 3mm, 200 ft.



Interconnects

- ERCAMY** 1 male-2 female twisted pair clear HEX audio cable
- ERCAFY** 1 female-2 male twisted pair clear HEX audio cable
- ERCA1** 1 ft. twisted pair clear HEX audio cable
- ERCA3** 3 ft. twisted pair clear HEX audio cable
- ERCA6** 6 ft. twisted pair clear HEX audio cable
- ERCA9** 9 ft. twisted pair clear HEX audio cable
- ERCA12** 12 ft. twisted pair clear HEX audio cable
- ERCA17** 17 ft. twisted pair clear HEX audio cable
- ERCA25** 25 ft. twisted pair clear HEX audio cable

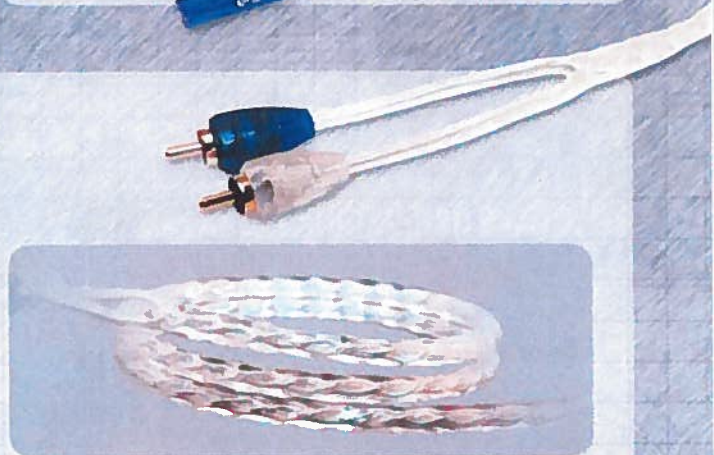

INSTALLATION ACCESSORIES

Battery Terminal

EBT Battery terminal with cover



Distribution Blocks

EDB 9.5mm to 6.5mm quad distribution block



EADB2 9.5mm to 6.5mm dual AGU distribution block



EADB4 9.5mm to 6.5mm quad AGU distribution block



EWDB2 15.5mm to 9.5mm dual ANL distribution block



In-line Fuseholders

EAFH Single AGU fuse holder



EWFH Single ANL fuse holder



Stiffening Capacitor

ECAP1 1 farad digital display stiffening cap



Ring Terminals

ERTC0 15.5mm screw style ring terminal, 1 pack

ERTC4 9.5mm screw style ring terminal, 1 pack

ERTC0-2 15.5mm ring terminals, 2 pack

ERTC4-4 9.5mm ring terminals, 4 pack

ERTC8-4 6.5mm ring terminals, 4 pack

EBS4-4 9.5mm spade terminals, 4 pack

EBS8-4 6.5mm spade terminals, 4 pack



Fuses

EAGU30-4 30 amp AGU fuse, 4 pack

EAGU40-4 40 amp AGU fuse, 4 pack

EAGU50-4 50 amp AGU fuse, 4 pack

EAGU60-4 60 amp AGU fuse, 4 pack

EAGU80-4 80 amp AGU fuse, 4 pack

EANL80 80 amp ANL fuse, 1 pack

EANL100 100 amp ANL fuse, 1 pack

EANL125 125 amp ANL fuse, 1 pack

EANL150 150 amp ANL fuse, 1 pack

EANL175 175 amp ANL fuse, 1 pack

EANL200 200 amp ANL fuse, 1 pack

EANL250 250 amp ANL fuse, 1 pack

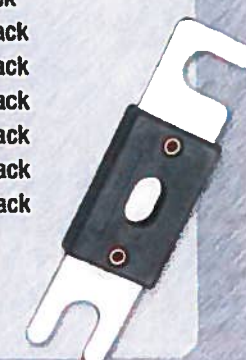



COMPETITION CAR AUDIO





SCOSCHE EFX AMPLIFIERS



The completely redesigned amplifier assortment has been engineered for the discerning car audio enthusiast. Each amplifier uses a MOSFET power supply and low noise circuitry for the highest performance capabilities. Boasting 0-12dB variable 45Hz bass boost, high and low level inputs, and five-way protection circuitry (thermal, short circuit, impedance, voltage, reverse polarity) these amplifiers are rock solid. The exterior features an illuminated logo badge and brushed aluminum heat sink which complement its sturdy aluminum side panels. The single sided connection layout makes it simple to adjust the system after installation. All EFX mono amplifiers feature an attractive remote level control with power LED.

EFX Mono Amplifier - 2000W Max Power

- Peak power output: 2000 watts
- 1 ohm: 1000 watts x 1 channel
- 2 ohms: 500 watts x 1 channel
- 4 ohms: 350 watts x 1 channel
- Included Remote Level Control with Power LED
- Illuminated Logo Badge
- Single Sided Connection Layout
- Sturdy Aluminum Side Panels
- Brushed Aluminum Heat sink and Top Plate
- 0-12dB Variable 45Hz Bass Boost
- Low Noise Circuitry
- Fully Variable 18dB LP Crossover



Part Number

SCX-1000C1

EFX 2 Channel Amplifier 500W Max Power

- Peak power output: 500 watts
- 2 ohms: 125 watts x 2 chan.
- 4 ohms: 100 watts x 2 chan.
- Low Noise Circuitry
- Fully Variable 12dB HP/Full/LP Crossover (40Hz-400Hz)
- 0-12dB Variable 45Hz Bass Boost
- Brushed Aluminum Heat sink and Top Plate
- Sturdy Aluminum Side Panels
- Single Sided Connection Layout
- Illuminated Logo Badge
- Bridged, 4 ohms: 250 watts x 1 chan.



Part Number

SCX-250C2

EFX 4 Channel Amplifier 800W Max Power

- Peak power output: 800 watts
- 2 ohms: 100 watts x 4 chan.
- 4 ohms: 60 watts x 4 chan.
- Low Noise Circuitry
- Fully Variable 12dB HP/Full/LP Crossover (40Hz-400Hz)
- 0-12dB Variable 45Hz Bass Boost
- Brushed Aluminum Heat sink and Top Plate
- Sturdy Aluminum Side Panels
- Single Sided Connection Layout
- Illuminated Logo Badge
- Bridged, 4 ohms: 400 watts x 2 chan.



Part Number

SCX-300C4

EFX Mono Amplifier 1000W Max Power

- Peak power output: 1000 watts
- 2 ohms: 500 watts x 1 channel
- 4 ohms: 350 watts x 1 channel
- Illuminated Logo Badge
- Single Sided Connection Layout
- Sturdy Aluminum Side Panels
- Brushed Aluminum Heat sink and Top Plate
- 0-12dB Variable 45Hz Bass Boost
- Low Noise Circuitry
- Included Remote Level Control with Power LED
- Fully Variable 18dB HP/Full/LP Crossover (40Hz-200Hz)



Part Number

SCX-500C1

EFX 4 Channel Amplifier 1200W Max Power

- Peak power output: 1200 watts
- Bridged, 4 ohms: 600 watts x 2 channel
- 2 ohms: 125 watts x 4 channel
- 4 ohms: 100 watts x 4 channel
- Low Noise Circuitry
- Fully Variable 12dB HP/Full/LP Crossover (40Hz-400Hz)
- 0-12dB Variable 45Hz Bass Boost
- Brushed Aluminum Heat sink and Top Plate
- Sturdy Aluminum Side Panels
- Single Sided Connection Layout
- Illuminated Logo Badge



Part Number

SCX-600C4



EFX - COMPETITION & PERFORMANCE SUBWOFFER



Optimized for small enclosures, EFX Competition subwoofers are bigger and stronger than ever. Beefy 2.5" Ultra-High temperature voice coils, heavy double stacked magnets and the large vented pole piece make up a motor structure that handles more power and plays louder than any EFX woofer before. With woven tinsel leads, heavy duty push terminals, stitched and bonded large rubber surrounds and one piece IMPP parabolic cones the EFX Competition subwoofers deliver!

10" Competition Subwoofer 4-Ohm DVC

- Durable Rubber Surround with Integrated Gasket
- High Strength One-Piece IMPP Cone
- Large, Double Stacked Magnets
- Nickel Plated Spring Loaded Push Terminals
- Optimized for Small Enclosures
- Woven Tinsel Leads
- Ultra High Temperature 2.5" Voice Coil

Part Number
SCX-C104D

10" Competition Subwoofer 4-Ohm SVC

- Nickel Plated Spring Loaded Push Terminals
- Woven Tinsel Leads
- High Strength One-Piece IMPP Cone
- Durable Rubber Surround with Integrated Gasket
- Max Pwr: 500 RMS Pwr: 250
- Stitched & Bonded Surround
- Large, Double Stacked Magnets
- Optimized for Small Enclosures
- Ultra High Temperature 2.5" Voice Coil

Part Number
SCX-C104

12" Competition Subwoofer 4-Ohm SVC

- Max Pwr: 600 RMS Pwr: 300
- Ultra High Temperature 2.5" Voice Coil
- Durable Rubber Surround with Integrated Gasket
- High Strength One-Piece IMPP Cone
- Large, Double Stacked Magnets
- Nickel Plated Spring Loaded Push Terminals
- Optimized for Small Enclosures
- Woven Tinsel Leads

Part Number
SCX-C124

12" Competition Subwoofer 4-Ohm DVC

- Max Pwr: 600 RMS Pwr: 300
- Durable Rubber Surround with Integrated Gasket
- High Strength One-Piece IMPP Cone
- Large, Double Stacked Magnets
- Nickel Plated Spring Loaded Push Terminals
- Optimized for Small Enclosures
- Ultra High Temperature 2.5" Voice Coil
- Woven Tinsel Leads

Part Number
SCX-C124D

15" Competition Subwoofer 4-Ohm DVC

- Max Pwr: 700 RMS Pwr: 350
- Woven Tinsel Leads
- Ultra High Temperature 2.5" Voice Coil
- Optimized for Small Enclosures
- Nickel Plated Spring Loaded Push Terminals
- Large, Double Stacked Magnets
- High Strength One-Piece IMPP Cone

Durable Rubber Surround with Integrated Gasket

Part Number
SCX-C154D

15" Competition Subwoofer 4-Ohm SVC

- Max Pwr: 700 RMS Pwr: 350
- Woven Tinsel Leads
- Ultra High Temperature 2.5" Voice Coil
- Optimized for Small Enclosures
- Nickel Plated Spring Loaded Push Terminals
- Large, Double Stacked Magnets
- High Strength One-Piece IMPP Cone
- Durable Rubber Surround with Integrated Gasket

Part Number
SCX-C154

EFX 12" Performance Subwoofer

- Max Pwr: 400 RMS Pwr: 200
- 4-Ohm Impedance
- High Grade Spring terminals
- High Strength One-Piece IMPP Cone
- High temperature 4-layer 2" voice coil
- UV Protected High Performance Foam Surround

Part Number
SCX-P124

EFX 10" Performance Subwoofer

- Max Pwr: 300 RMS Pwr: 150
- High Grade Spring terminals
- High temperature 4-layer 2" voice coil
- 4-Ohm Impedance
- UV Protected High Performance Foam Surround
- High Strength One-Piece IMPP Cone

Part Number
SCX-P104



EFX - COMPETITION & PERFORMANCE LOUDSPEAKER



EFX Competition Loudspeakers are designed to elevate sound quality, performance, durability and installation flexibility to a new level. The EFX C65 and C692 both feature 12dB, 2-way integrated crossovers so you no longer have to search for a location to mount your crossover cases. The C65 convertible component set can be mounted in either a coaxial or component alignment with it's separate tweeter for ideal positioning. The C65 loudspeaker set also includes our patent pending Universal Backmount Adapter for quick, secure and easy tweeter mounting behind factory panels or A-pillars.

6.5"/6.75" Convertible Component Set

- Steel Mesh Grille
- 2-way Tweeter Attenuation Switch (0,-3 dB)
- 19mm Titanium Dome Tweeter
- High Temperature Voice Coils
- 4-Ohm Impedance
- Max Pwr: 200 RMS Pwr: 100
- Durable Rubber Surrounds
- IMPP Cones
- Integrated 12dB Crossovers
- Thermal PTC Tweeter Protection

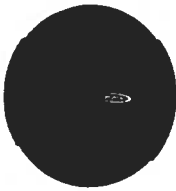

Part Number
SCX-C65

6x9" 2-Way Coaxial

- Max Pwr: 200 RMS Pwr: 100
- Steel Mesh Grille
- Integrated 12dB Crossovers
- IMPP Cones
- High Temperature Voice Coils
- Durable Rubber Surrounds
- 4-Ohm Impedance
- 2-way Tweeter Attenuation Switch (0,-3 dB)
- 19mm Titanium Dome Tweeter
- Thermal PTC Tweeter Protection



Part Number
SCX-C692

EFX Performance loudspeakers are value engineered with high quality materials and packed with features. The EFX Performance line consists of 2-way coaxials, 3-way triaxials and a 6.5" component set to provide a solution for almost any application. With consistent performance and reliability, the all new EFX Performance loudspeakers are perfect for your every day install.

EFX 10" Performance Subwoofer

- Max Pwr: 300 RMS Pwr: 150
- High Grade Spring terminals
- High temperature 4-layer 2" voice coil
- 4-Ohm Impedance
- UV Protected High Performance Foam Surround
- High Strength One-Piece IMPP Cone



Part Number
SCX-P104

EFX 12" Performance Subwoofer

- Max Pwr: 400 RMS Pwr: 200
- 4-Ohm Impedance
- High Grade Spring terminals
- High Strength One-Piece IMPP Cone
- High temperature 4-layer 2" voice coil
- UV Protected High Performance Foam Surround



Part Number
SCX-P124

3.5" 2-Way Coaxial

- Thermal PTC Tweeter Protection
- High Temperature Voice Coils
- 4-Ohm Impedance
- IMPP Cones
- Max Pwr: 40 RMS Pwr: 20



Part Number
SCX-P352

4" 2-Way Coaxial

- Max Pwr: 60 RMS Pwr: 30
- 4-Ohm Impedance
- High Temperature Voice Coils
- IMPP Cones
- Thermal PTC Tweeter Protection



Part Number
SCX-P402

4x6" 2-Way Coaxial

- Max Pwr: 60 RMS Pwr: 30
- 4-Ohm Impedance
- High Temperature Voice Coils
- IMPP Cones
- Thermal PTC Tweeter Protection

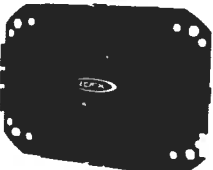

Part Number
SCX-P462

5.25" 2-Way Coaxial

- Thermal PTC Tweeter Protection
- IMPP Cones
- High Temperature Voice Coils
- 4-Ohm Impedance
- Max Pwr: 100 RMS Pwr: 50



Part Number
SCX-P522

HeXaD™

PREMIUM AUDIO CABLES

EFX HeXaD™ premium audio cables are designed with the goal of achieving the purest sound quality that even the most critical audiophiles will appreciate. Our cables feature Litz construction enhanced by Accuflow Frequency Tuned conductors, Dual Ground Path Braid Geometry and Rhodium plated RCA ends.



The Litz wire used in the HeXaD audio cable consists of a number of individually insulated copper strands designed to minimize signal losses. When Litz construction is used with a broad range of frequencies such as the audio spectrum (20Hz -20KHz), high frequencies travel more efficiently on a larger number of smaller strands where low frequencies travel more efficiently over a smaller number of larger strands. Our multiple gauge Accuflow™ frequency tuned conductors overcome this limitation and allow all audio frequencies to pass with extremely low impedance.



Dual Opposing Ground Path Braid Geometry is designed to minimize losses caused by the Proximity Effect. The configuration of the braided conductors is designed to cause cancellation of the Proximity Effect by equalizing the magnetic currents in opposing channels. HeXaD Audio Cables are braided by hand because there is no machine capable of producing this unique design.



Rhodium has a very low contact resistance as well as an extremely high resistance to oxidation making it the ideal material for use on the contact surfaces of RCA audio cable connectors. Because Rhodium is many times the cost of gold, Rhodium connectors are a feature generally only found in ultra high end home audio cables. We chose to use this material because it was the only way to be sure we truly achieved the goals we set out for our HeXaD cable.



For convenience and installation flexibility we have included interchangeable Front, Rear and Subwoofer markers. To help protect the HeXaD cable body from damage we have also included a protective woven nylon cover.

All of these features have been combined to result in a cable with unmatched performance and incredible musical clarity.



SCOSCHE EFX PRODUCTS



The injection molded splitter features interchangeable channel markers making it easy to differentiate the front, rear and subwoofer channels.

- OFC Copper Accuflow Frequency Tuned Conductors
- Litz Individually Insulated Strand Construction
- HeXaD Braid Geometry with Dual Opposing Ground Path
- Low Profile Rhodium Plated RCA Ends
- Durable Protective Nylon Overbraid
- Interchangeable Front, Rear and Sub Identification Markers

HeXaD3: 3 ft. - 2 channel RCA

HeXaD6: 6 ft. - 2 channel RCA

HeXaD9: 9 ft. - 2 channel RCA

HeXaD12: 12 ft. - 2 channel RCA

HeXaD17: 17 ft. - 2 channel RCA

HeXaD20: 20 ft. - 2 channel RCA

HeXaDFF: Y-cable RCA (1 male 2 female)

HeXaDMM: Y-cable RCA (1 female 2 male)

US Patent #5,956,844

DELTA™

DISTRIBUTION BLOCKS

Through creative design and stringent testing we have developed a system with many unique features. Performance and ergonomics were considered throughout every step of development. All blocks feature the highest grade materials, EZ-insert dual gauge wire inputs/outputs and impact resistant polycarbonate covers. DELTA™, the most advanced power distribution system in the industry.

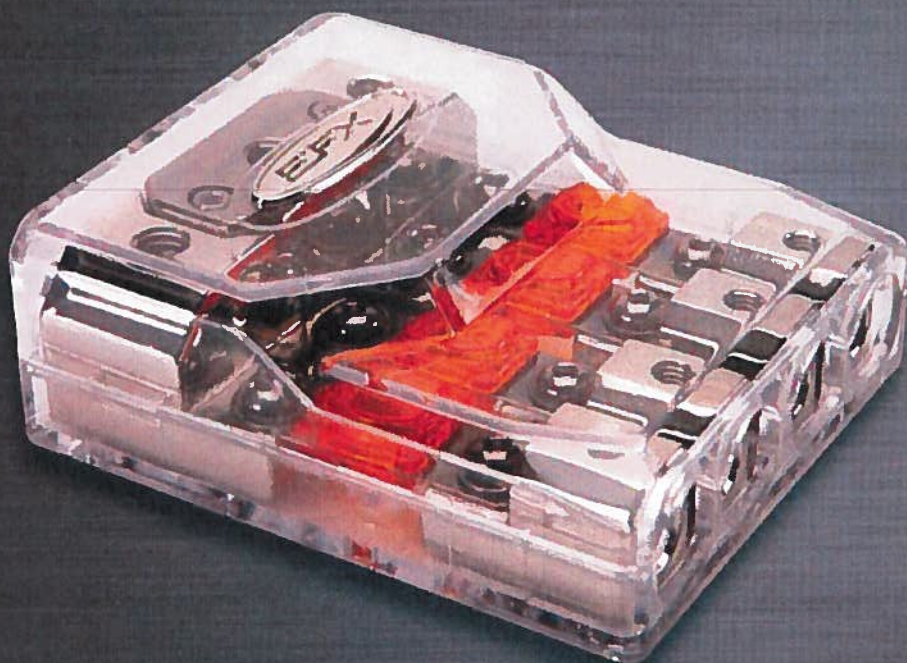

DBLOCK - Distribution/Combination Power-Ground Block:

- Configurable as a Distribution or Power-Ground Combo Block
- 0/4 AWG Inputs with EZ-Insert Profiles
- 4/8 AWG Outputs with EZ-Insert Profiles
- Uses Compact AFC Fuses (sold separately)
- Durable Polycarbonate Protective Cover



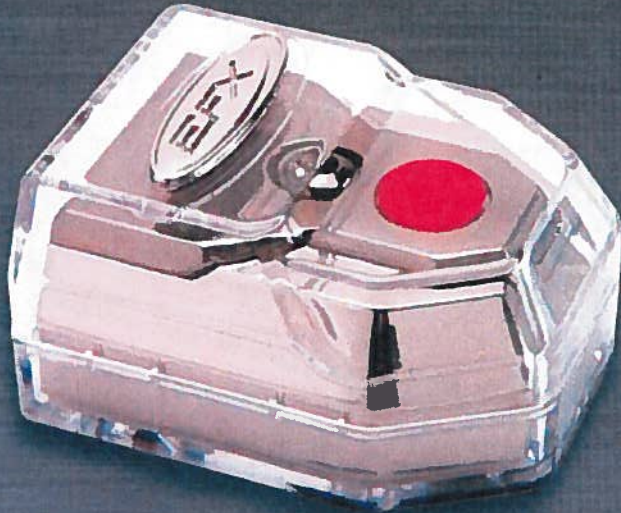

DCLAMP - Compression Wedge Battery Clamp:

- Compression Wedge Clamping System
- Interchangeable Polarity Markers
- Negative Terminal Adapter
- Jump Start Attachment
- Two 0 or 4 AWG and Two 8 AWG Outputs with EZ-Insert Profiles
- Durable Polycarbonate Protective Cover

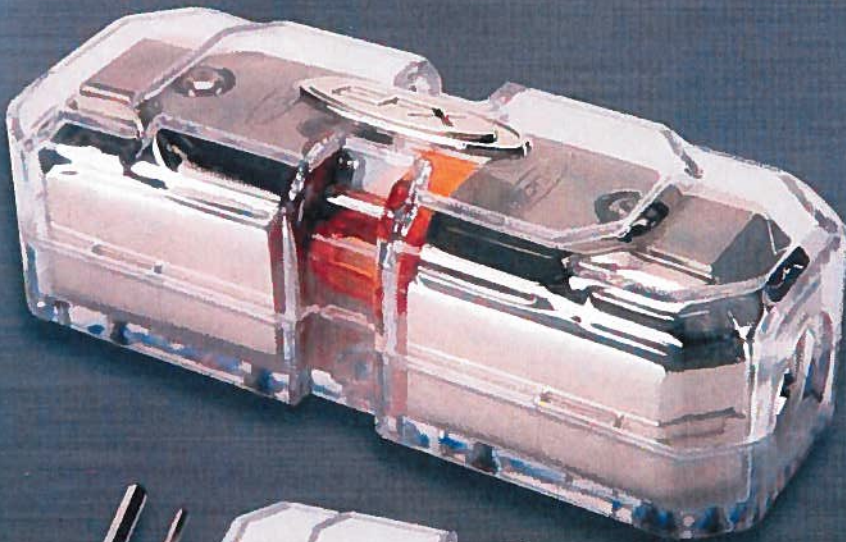
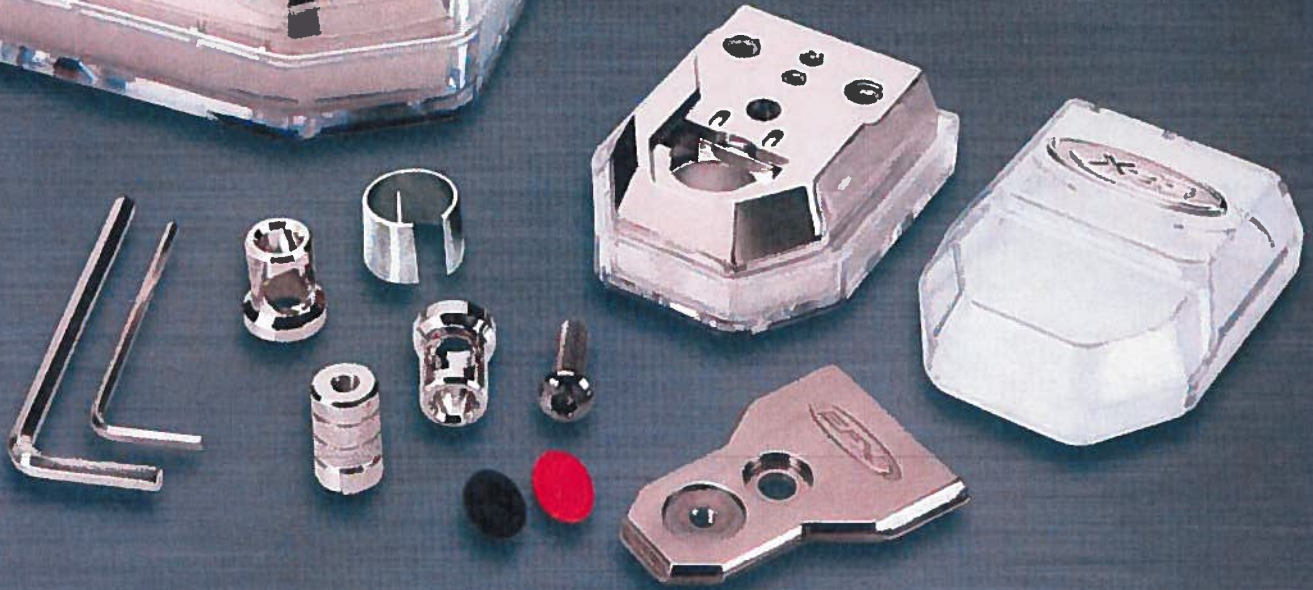

DFUSE - High Current AFC Fuse Holder:

- High Current Dual AFC Fuse Holder (Fuses sold separately)
- 0/4 AWG Input with EZ-Insert Profile
- 0/4 AWG Output with EZ-Insert Profile
- Durable Polycarbonate Protective Cover





AUDIO CABLES & AMP KITS

reVo™ deluxe audio cables build upon the successful EFX G2™ design and feature improved triple shielded, twisted pair construction to maximize noise rejection. High grade Oxygen Free Copper conductors are used for efficient signal transfer with dual layer jackets for added protection.

DELUXE AUDIO CABLES

- Triple Shielded
- Twisted Pair Noise Rejection Construction
- OFC Copper Conductors
- Low Profile Molded RCA Ends
- Double Layer Jacket

- reVo3: 3 ft. - 2 channel RCA
- reVo6: 6 ft. - 2 channel RCA
- reVo9: 9 ft. - 2 channel RCA
- reVo12: 12 ft. - 2 channel RCA
- reVo17: 17 ft. - 2 channel RCA
- reVo20: 20 ft. - 2 channel RCA
- reVoFF: Y-cable RCA (1 male 2 female)
- reVoMM: Y-cable RCA (1 female 2 male)



AMPLIFIER KITS

reVo amp kits are some of the last kits available to use true gauge wire that strictly follows the American Wire Gauge (AWG) standard. The FLUX™ power and ground wire included in the amp kits is made with high strand count pure Oxygen Free Copper that ensures your amps are getting the power that they need to perform at their best. Pre-terminated with ring terminals for ease of installation while the durable nylon overbraid provides extra protection.



reVoPAK4 - 4 gauge Single Amp Power & Audio Kit

- 17' reVo RCA Cable
- 17' 4AWG Power Cable with Protective Mesh Cover
- 4' 4AWG Ground Cable
- Mini Wafer Fuse Holder
- 17' Remote Turn On Lead (not shown)
- Water Proof Grommet
- Hardware Pack



reVoPAK8 - 8 gauge Single Amp Power & Audio Kit

- 17' reVo RCA Cable
- 17' 8AWG Power Cable with Protective Mesh Cover
- 4' 8AWG Ground Cable
- Mini Wafer Fuse Holder
- 17' Remote Turn On Lead (not shown)
- Water Proof Grommet
- Hardware Pack

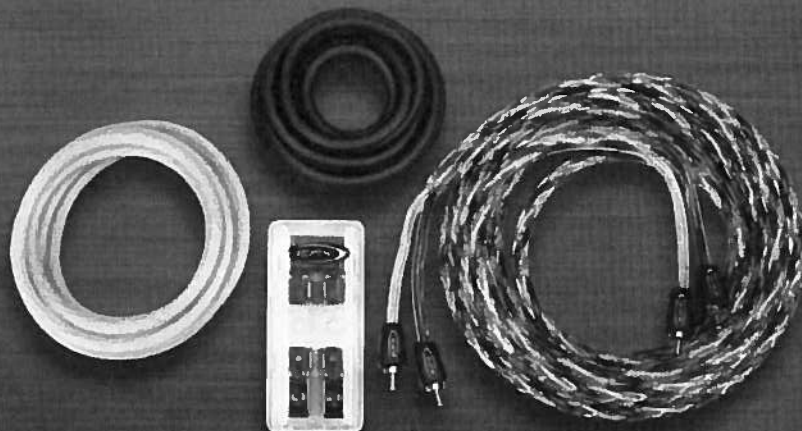

reVoPAKX - Dual Amp Add on Kit (use with reVoPAK4)

- 17' reVo RCA Cable
- 8' 8AWG Power Cable
- 6' 8AWG Ground Cable
- 8' Remote Turn On Lead (not shown)
- One-4AWG in to Two-8AWG out CORE Distribution Block
- Hardware Pack

STATUS™ DIGITAL BLOCKS

Proper voltage for your audio system is critical for optimal performance. EFX STATUS™ blocks monitor your voltage every step of the way so you can be sure your system is performing at it's best. STATUS™ blocks feature EZ insert dual gauge wire inputs/outputs for installation flexibility and screw down impact resistant covers.



SCLAMPN - Negative Battery Clamp:

- Fits negative (-) terminal
- (1) 0 AWG output
- (1) 4 AWG output
- (2) 8 AWG output

SCLAMP - Positive Battery Clamp:

- Fits Positive + terminal
- (1) 0 AWG output
- (1) 4 AWG output
- (2) 8 AWG output
- 3 digit LED voltage display

SFUSE - Wafer Fuse Holder:

- 0 or 4 gauge inputs/output
- 3 digit LED voltage display
- High current ANL wafer fuse (up to 300 amps)
- Dual grounding options (self grounding or pigtail lead)



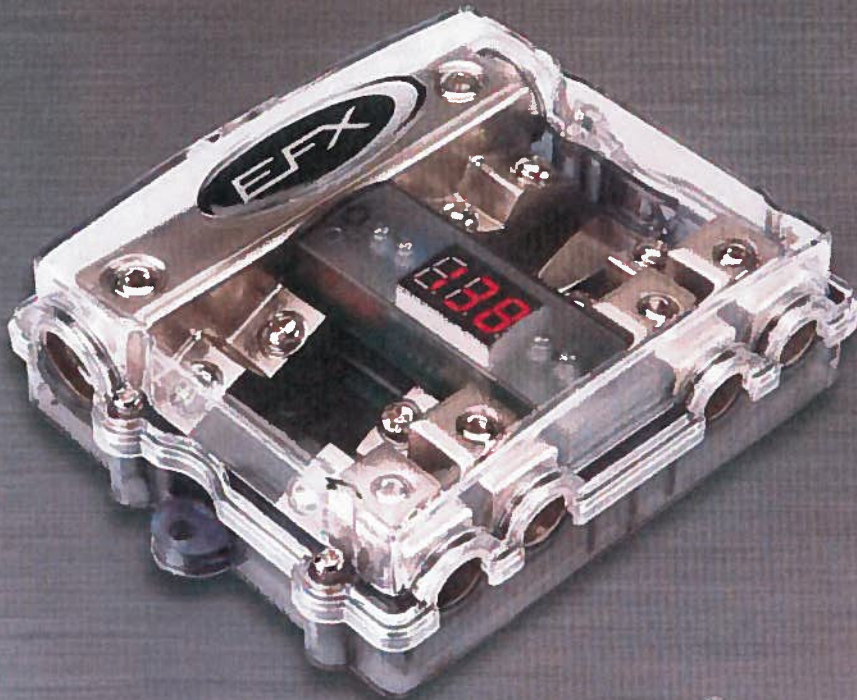

SBLOCK4 - 4-4 Gauge Out Distribution Block:

- (3) 0 or 4 AWG input
- (4) 4 or 8 AWG outputs
- Uses compact AFC mini wafer fuses
- 3 digit LED voltage display
- Dual grounding options (self grounding or pigtail lead)



SBLOCK2 - 2-4 Gauge Out Distribution Block:

- (3) 0 or 4 AWG input
- (2) 4 or 8 AWG outputs
- Uses compact AFC mini wafer fuses
- 3 digit LED voltage display
- Dual grounding options (self grounding or pigtail lead)



SCAP - 1 Farad 20 Volt Capacitor:

- LCD digital voltage display for system monitoring
- Includes mounting brackets, ring terminals, and charging resistor
- High strength protective cover

CORE™ AUDIO CABLES & BLOCKS

CORE™ audio cables and blocks are designed for great performance at a great value. Each audio cable is made with OFC copper for efficient signal transfer. The low profile RCA connectors feature 24K gold plated ends for optimal contact. CORE battery terminals, fuse holders and distribution blocks feature nickel plated terminals and impact resistant covers for enhanced durability. CORE audio cables and blocks are extremely reliable and a great solution for your everyday install.

AUDIO CABLES

CORE1: 1 ft. - 2 channel RCA	CORE17: 17 ft. - 2 channel RCA
CORE3: 3 ft. - 2 channel RCA	CORE20: 20 ft. - 2 channel RCA
CORE6: 6 ft. - 2 channel RCA	CORE25: 25 ft. - 2 channel RCA
CORE9: 9 ft. - 2 channel RCA	COREFF: Y-cable RCA (1 male 2 female)
CORE12: 12 ft. - 2 channel RCA	COREMM: Y-cable RCA (1 female 2 male)



CAFH - In-Line AGU Fuse Holder
 • for 8 or 4 gauge wire

CMWFH - High Amperage MINI Wafer Fuse Holder
 • for 8 or 4 gauge wire



CWFH - Wafer Fuse Holder
 • for 4 or 1/0 gauge wire



CCLAMP - Battery Clamp

- 1-1/0 gauge
- 1-4 gauge
- 1-8 gauge outputs

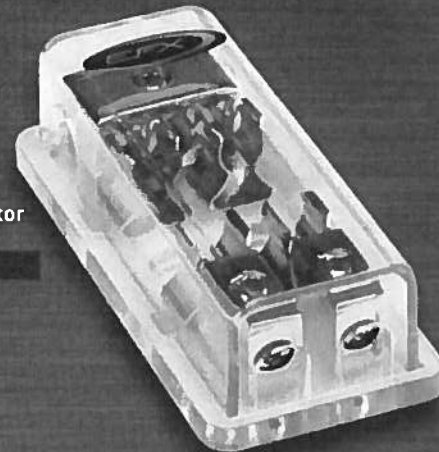

CBLOCKA2 - AGU Fuse Power Distributor

- 1-4 gauge in
- 2-8 gauge out



CBLOCKA4 - AGU Fuse Power Distributor

- 1-4 gauge in
- 4-8 gauge out



CBLOCKM2 - MAXI Fuse Power Distributor

- 1-4 gauge in
- 2-8 gauge out

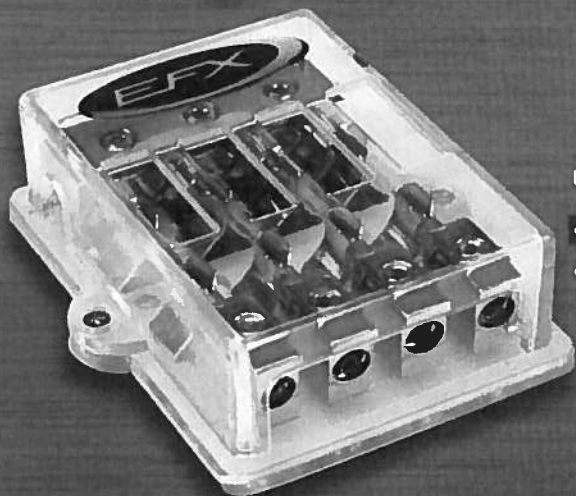

CBLOCKM4 - MAXI Fuse Power Distributor

- 1-4 gauge in
- 4-8 gauge out



CBLOCK48 - Ground Distributor

- 1-4 gauge in
- 4-8 gauge out

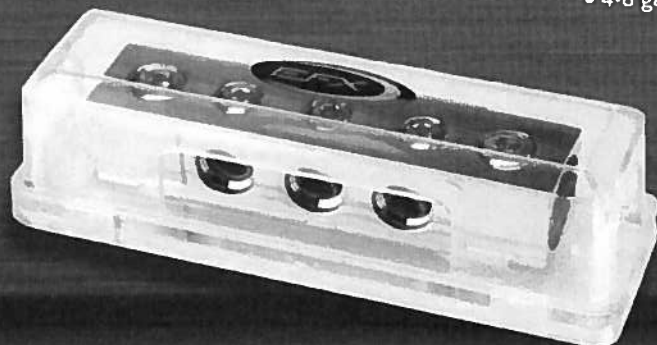

CBLOCK04 - Ground Distributor

- 2-1/0 gauge in/out
- 3-4 gauge in/out



SCOSCHE EFX PRODUCTS



FLUX™

POWER & SPEAKER WIRE

FLUX™ power and speaker wire strictly follow the American Wire Gauge (AWG) standard ensuring that your amps and speakers are getting the power that they need to perform at their best. The ultra high strand count and frosted PVC jacket on the power wire increases the flexibility making for hassle free installations. Each individual strand of the Oxygen Free Copper wire is plated with a tin to prevent oxidation and provide unmatched reliability.

POWER WIRE

FP0B-50: Frosted Black Power Wire 1/0 gauge 50 ft. roll

FP0BL-50: Frosted Blue Power Wire 1/0 gauge 50 ft. roll

FP0C-50: Frosted Clear Power Wire 1/0 gauge 50 ft. roll

FP0R-50: Frosted Red Power Wire 1/0 gauge 50 ft. roll

FP4B-125: Frosted Black Power Wire 4 gauge 125 ft. roll

FP4BL-125: Frosted Blue Power Wire 4 gauge 125 ft. roll

FP4C-125: Frosted Clear Power Wire 4 gauge 125 ft. roll

FP4R-125: Frosted Red Power Wire 4 gauge 125 ft. roll

FP8B-250: Frosted Black Power Wire 8 gauge 250 ft. roll

FP8BL-250: Frosted Blue Power Wire 8 gauge 250 ft. roll

FP8C-250: Frosted Clear Power Wire 8 gauge 250 ft. roll

FP8R-250: Frosted Red Power Wire 8 gauge 250 ft. roll



- Strictly follows the American Wire Gauge standard
- Tinned Oxygen Free Copper ensures superior conductivity
- Ultra high strand count provides unmatched flexibility

SPEAKER WIRE

FS12-125: Frosted Black Speaker Wire 12 gauge 125 ft. roll

FS14-250: Frosted Black Speaker Wire 14 gauge 250 ft. roll

FS16-250: Frosted Black Speaker Wire 16 gauge 250 ft. roll

FS18-500: Frosted Black Speaker Wire 18 gauge 500 ft. roll

FS9W-250: EIA Standard 8 Speaker + Turn On 18 gauge 250 ft. roll

12 GAUGE OXYGEN FREE COPPER SPEAKER CABLE



SUBWOOFER ENCLOSURES

SEALED SINGLE SPEAKER/SUBWOOFER ENCLOSURES

SE6900CC: Pre-cut for 6x9" speaker

SE10CC: Pre-cut for 10" sub - .75 cu. ft. internal volume

SE12CC: Pre-cut for 12" sub - 1.25 cu. ft. internal volume

SE15CC: Pre-cut for 15" sub - 1.70 cu. ft. internal volume

SEALED SINGLE SUBWOOFER ENCLOSURES FOR TRUCKS

SET10CC: Pre-cut for 10" sub - .60 cu. ft. internal volume

SET12CC: Pre-cut for 12" sub - .90 cu. ft. internal volume

SEALED DUAL SUBWOOFER ENCLOSURES

SE102CC: Pre-cut for two 10" subs
.75 cu. ft. internal volume per side

SE122CC: Pre-cut for two 12" subs
1.25 cu. ft. internal volume per side

SE152CC: Pre-cut for two 15" subs
1.70 cu. ft. internal volume per side

SLOT PORTED SINGLE SUBWOOFER ENCLOSURES

SEV10CC: Pre-cut for 10" sub - 1.25 cu. ft. internal volume

SEV12CC: Pre-cut for 12" sub - 1.70 cu. ft. internal volume

SEV15CC: Pre-cut for 15" sub - 2.50 cu. ft. internal volume



All enclosures are made with CARB Compliant wood products which have been formulated to significantly reduce formaldehyde emissions

SLOT PORTED DUAL SUBWOOFER ENCLOSURES

SE102CC: Pre-cut for two 10" subs
1.30 cu. ft. internal volume per side

SE122CC: Pre-cut for two 12" subs
1.70 cu. ft. internal volume per side

SE152CC: Pre-cut for two 15" subs
2.50 cu. ft. internal volume per side



sneakPEEK auto - Composite A/V Cable for Mobile Video Systems

With the sneakPEEK *auto* you can easily connect your iPad, iPhone or iPod directly to your car entertainment system through the RCA audio/video inputs. This innovative cable also provides 2.1 A of power to keep your device charged.

Advantages and Applications

Watch movies, TV shows, music videos or listen to high quality music in your car. The sneakPEEK *auto* simply connects to the bottom of your device. 9 ft. of cable length give you the mobility and freedom to use your device wherever you like in your vehicle.

The integrated toggle switch allows you to change between playing video on an external video source and easily back to your devices screen while continuing to charge.

Durable Design

The tapered metal RCA barrels provide a superior connection with no signal loss. Copper braided shielding and an integrated foil wrap create a durable and long-lasting cable.

Works With

iPad 2, iPad, iPhone 4, iPhone 3GS, iPhone 3G, iPhone, iPod touch (1st, 2nd, 3rd and 4th generation), iPod nano (3rd, 4th, 5th and 6th generation) and iPod classic.

Compatible with the following Apps:

iPod video playback, Photos, AirVideo, YouTube, Netflix (iPhone 4, iPad and iPad 2) and Keynote



- 2.1 Amp charging for use with iPad, iPhone or iPod
- Composite video output
- 12V Accessory wire and Ground Wire for pass-through charging
- Gold and nickel plated RCA connectors
- Left & right audio output



Part Number

CS-CS-103



OMEGA SOLUTIONS



**ALL NEW
REMOTE START
MODELS!**

STAND OUT FROM THE CROWD.



*PROTECTING VEHICLES FOR OVER 35 YEARS.
NOW PROTECTING YOUR BUSINESS!*





EXCALIBUR - ALARM & REMOTE STARTS



MODEL: OM-AL1830EDPB

Deluxe 2-Way Vehicle Security & Remote Start System With BLADE Compatibility

The AL-1830-EDPB offers the latest in security and convenience technology. Equipped with Omega's ECHO 2-way technology, you can keep the status of your vehicle right at your fingertips! Intuitive reporting gives you real-time alerts for all security and convenience functions. The built-in remote start capability will keep your vehicle warm in the winter and cool in the summer. Our state-of-the-art vehicle security platform offers unsurpassed vehicle protection that can only be offered by Excalibur's 30+ year legacy.



Features:

- 2-way controller included
- 4 button transmitter included
- ECHO compatible
- Multi-vehicle capability
- BLADE cartridge compatible
- Low temp auto start
- Low voltage auto start
- Run time extender
- Run time expiration warning
- Parking timer
- Remote start timer
- Stick shift compatible remote start

- Turbo timer
- Selectable vehicle image
- Limited lifetime warranty on all components
- Up to 4 aux outputs
- Data port that supports iDatalink & Trilogix protocols
- Includes dual zone impact sensor
- Coded override (99 possible combinations)
- Starter Interrupt included
- Mini 2-in-1 Psyren included
- Locks when triggered
- Simultaneous horn honk and siren alert
- ATV / Unauthorized Transmitter Alert™

MODEL: OM-AL2030EDPB

1-mile Deluxe 2-Way Vehicle Security & Remote Start System With BLADE Compatibility

The AL-2030-EDPB offers the latest in security and convenience technology. Equipped with Omega's ECHO-COLOR 2-way technology, you can keep the status of your vehicle right at your fingertips! Intuitive reporting gives you real-time alerts for all security and convenience functions. The built-in remote start capability will keep your vehicle warm in the winter and cool in the summer. Our state-of-the-art vehicle security platform offers unsurpassed vehicle protection that can only be offered by Excalibur's 30+ year legacy.



Features:

- 2-way controller included
- 4 button transmitter included
- ECHO compatible
- 900MHz spread spectrum technology
- Up to 1-mile of range
- Multi-vehicle capability
- BLADE cartridge compatible
- Low temp auto start
- Low voltage auto start
- Run time extender
- Run time expiration warning
- Parking timer
- Remote start timer
- Stick shift compatible remote start
- Turbo timer

- Selectable vehicle image
- Limited lifetime warranty on all components
- Up to 4 aux outputs
- Data port that supports iDatalink & Trilogix protocols
- Includes dual zone impact sensor
- Coded override (99 possible combinations)
- Starter Interrupt included
- Mini 2-in-1 Psyren included
- Locks when triggered
- Simultaneous horn honk and siren alert
- ATV / Unauthorized Transmitter Alert™



OMEGA SOLUTIONS



MODEL: OM-AL1630EDP

Deluxe Vehicle Security & Remote Start System With BLADE Compatibility

The AL-1630-EDPB offers the latest in security and convenience technology. This feature-rich security/remote start system will deter even the most determined or sophisticated thief. The built-in remote start capability will keep your vehicle warm in the winter and cool in the summer. Our



Features:

- Two 4 button transmitters included
- ECHO compatible
- BLADE cartridge compatible
- Low temp auto start
- Low voltage auto start
- Run time extender
- Run time expiration warning
- Stick shift compatible remote start
- Turbo timer
- Selectable vehicle image

- Limited lifetime warranty on all components
- Up to 4 aux outputs
- Data port that supports iDatalink 7 Trilogix protocols
- Includes dual zone impact sensor
- Coded override (99 possible combinations)
- Starter Interrupt included
- Mini 2-in-1 Psyren included
- Locks when triggered
- Simultaneous horn honk and siren alert
- ATV / Unauthorized Transmitter Alert™

MODEL: OM-RS320EDP

Deluxe Keyless Entry & Remote Start System

Excalibur is one of the most recognized and respected names in vehicle convenience. This feature-rich system will put vehicle comfort at your fingertips. The Excalibur RS-320-EDP offers the latest in remote start and convenience technology. You can even put the status of your vehicle in your hand with the optional ECHO-2 two-way LCD controller



Features:

- Extended operating range
- Two 4-button extended range transmitters
- Extended range window-mount receiver with integrated status lights and override switch
- Keyless entry
- Ignition controlled door locks
- Remote start compatible with gas or diesel engines
- Selectable engine run times

- Low voltage automatic start prevents a dead car battery
- Turbo timer - 1, 2, or 3 minute run time!
- Optional trunk release
- Optional horn honk for audible confirmation
- Flashing light output.
- Optional anti-grind feature to protect your starter.
- Pit-stop operation
- All parts are built to the highest quality standards and are backed by our LIMITED LIFETIME warranty.



OMEGA SOLUTIONS



MODEL: OM-RS120DP Deluxe Add-on Remote Start System

The RS-120-DP offers the latest in convenience technology. The remote start capability will keep your vehicle warm in the winter and cool in the summer.



Features:

- Activates from almost any existing keyless entry or security system
- Includes status light and override switch
- Remote start compatible with gas or diesel engines!
- Selectable engine run times!
- Low voltage automatic start prevents a dead car battery!
- Turbo timer - 1, 2, or 3 minute run time!
- Flashing light output.
- Optional anti-grind feature to protect your starter.
- Pit-stop operation
- All parts are built to the highest quality

MODEL: OM-RS210DP One Button Remote Start System

Excalibur is one of the most recognized and respected names in vehicle convenience. This feature-rich system will put vehicle comfort at your fingertips. The Excalibur RS-210-DP offers the latest in remote start and convenience technology.



Features:

- Two 1-button extended range transmitters!
- Extended range window-mount receiver with integrated status lights and override switch
- Unlock control for easy vehicle access during remote start
- Remote start compatible with gas or diesel engines!
- Selectable engine run times
- Low voltage automatic start prevents a dead car battery
- Turbo timer - 1, 2, or 3 minute run time
- Flashing light output
- Optional anti-grind feature to protect your starter.
- Pit-stop operation
- All parts are built to the highest quality standards and are backed by our LIMITED LIFETIME warranty.



OMEGA SOLUTIONS



IMMOBILIZER BYPASS

The ideal solution for quick and cost effective installations, the Omegalink series includes a wide array of modules preloaded with vehicle-specific, immobilizer bypass or doorlock bypass firmware. Ready to install right out of the box, our modules can also be updated* online prior to installation, to ensure maximum compatibility with your vehicle. *OL-LOADER required and sold separately.



OM-OL-DB-GM1 Compatible with most GM vehicles, our OL-DB-GM1 module supports GM J1850 doorlock interface, data immobilizer bypass* and controls various convenience features without relinquishing a spare key upon installation.
*OL-RNG-GM3 ring may be required and sold separately.

OM-OL-DB-GM Compatible with most GM vehicles including CANbus-enabled models, our OL-DB-GM module supports doorlock interface, data immobilizer bypass* and various convenience features without relinquishing a spare key upon installation.
*OL-RNG-GM3 ring may be required and sold separately.

OM-OL-DB-HA Compatible with most Honda/Acura vehicles, our OL-DB-HA module supports doorlock interface, immobilizer bypass and various convenience features without relinquishing a spare key upon installation.

OM-OL-DB-CH1 Compatible with most Chrysler vehicles built prior to 2004, our OL-DB-CH1 module supports doorlock interface, RF immobilizer bypass* and various convenience features without relinquishing a spare key upon installation.
*OL-RNG-C1 ring included.

OM-OL-DB-CH3 Compatible with most CANbus-enabled Chrysler vehicles, our OL-DB-CH3 module supports doorlock interface, RF immobilizer bypass* and various convenience features without relinquishing a spare key upon installation.
*OL-RNG-C2 ring included. OL-RNG-C1 ring may be required and sold separately.



Part Number	Description
PIE-AV-IPH	Audio Charging & Video
PIE-CHRY02/PC-POD2	02-UP CHRYSLER IPOD
PIE-CHRY98/PC-POD2	98-01 CHRYSLER IPOD
PIE-EIS-LOC-T	2-Channel High/low converter
PIE-FRD04-AUX	FORD CAN-BUS AUX INPUT
PIE-FRD04-POD/S	06-UP FORD CANBUS IPOD
PIE-GM12-AUXV2	01-04 GM CLASS 2 AUX IN
PIE-GM12-POD/S	GM CLASS 2 IPOD W/ AUX
PIE-GM12-R1	GM12-POD/S HARNESS FOR
PIE-GM12-X1	GM12-POD/S HARNESS W/ XM
PIE-GM2L-POD/S	GM CLASS 2/LAN IPOD
PIE-GM2L-R03	GM2L - 03-07 CLASS 2 HARNESS
PIE-GM2L-X03	GM2L - 07 GM CLASS 2 + XM
PIE-GMLAN-POD/S	GM LAN-BUS TO IPOD W/
PIE-GMLAN-R1	GMLAN-POD/S HARNESS FOR
PIE-GMLAN-X1	GMLAN-POD/S HARNESS w/ XM
PIE-HON03-AUX	03-10 HONDA/ACURA AUX IN
PIE-HON03-POD/S	03-07 HONDA IPOD
PIE-KNW/USB-AV2	KENWOOD USB TO IPOD AV
PIE-PIO/USB-50V	PIONEER CABLE FOR IPOD
PIE-TOY03-AUX2	03-10 TOY/LEX/SCION AUX IN
PIE-TOY03-POD/S	TOY/LEX IPOD W/AUX
PIE-TOY03-R1	TOY03-POD/S HARNESS FOR
PIE-TOY-AUX2	98-05 TOYOTA/ISUZU AUX IN



RENEGADE PRODUCTS



HAINES ENTERPRISES

Proudly Presents



PURE CAR AUDIO ENGINES

RENEGADE



RENEGADE AMPLIFIERS

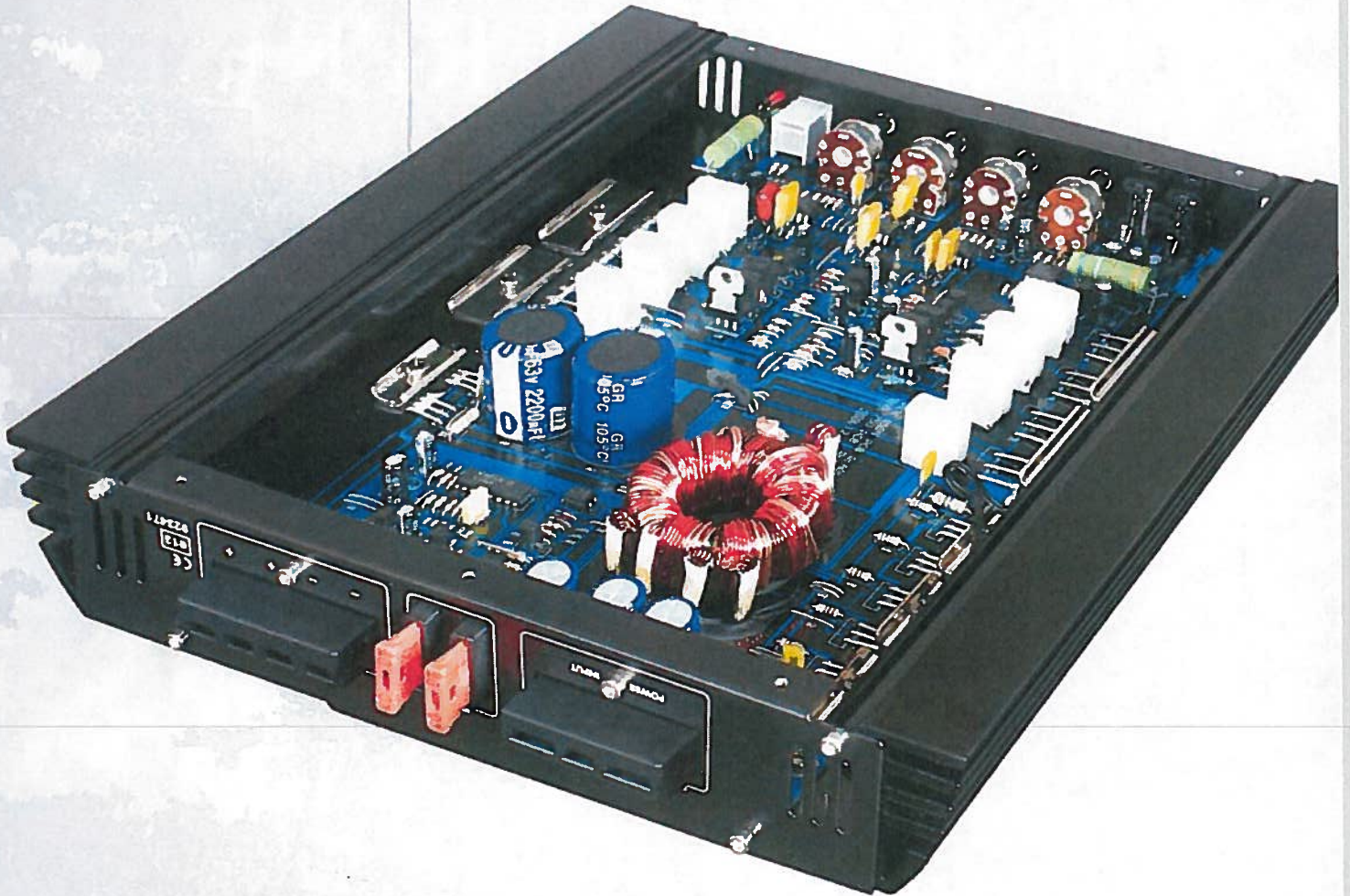

MONO AMPLIFIER

REN850S

- 1 x 225 Watts RMS into 4 Ohms
- 1 x 425 Watts RMS into 2 Ohms
- 1 x 450 Watts Max. into 4 Ohms
- 1 x 850 Watts Max. into 2 Ohms
- MOSFET Power Supply
- RCA Inputs and Outputs
- 2 Ohm Stability
- Lowpass filter 40 - 150 Hz
- Subsonic filter 15 - 55 Hz
- Bass Boost 0 - 12 dB
- Bass Remote Controller
- Dimensions: 10" x 2.25" x 11"





RENEGADE AMPLIFIERS



4-CHANNEL AMPLIFIER

REN1100S

- 4 x 75 Watts RMS into 4 Ohms
- 4 x 135 Watts RMS into 2 Ohms
- 4 x 150 Watts Max. into 4 Ohms
- 4 x 275 Watts Max. into 2 Ohms
- MOSFET Power Supply
- High level Inputs
- RCA Inputs and Outputs
- 2 Ohm Stability
- Mono bridgeable on CH 3/4
- Lowpass filter 50 - 250 Hz
- Bass Boost Switch 0/+6/+12 db
- 2 x Highpass filter 80 - 2000 Hz
- Dimensions: 10" x 2.25" x 13.75"



2-CHANNEL AMPLIFIER

REN550S

- 2 x 75 Watts RMS into 4 Ohms
- 2 x 135 Watts RMS into 2 Ohms
- 2 x 150 Watts Max. into 4 Ohms
- 2 x 275 Watts Max. into 2 Ohms
- MOSFET Power Supply
- High level Inputs
- RCA Inputs and Outputs
- 2 Ohm Stability
- Mono bridgeable
- Tri-Mode Operation
- Highpass filter 80 - 2000 Hz
- Lowpass filter 50 - 250 Hz
- Bass Boost Switch 0/+6/+12 db
- Dimensions: 10" x 2.25" x 9"



PURE CAR AUDIO ENGINES



RENEGADE SUBBOXES



DUAL BANDPASS

GTB2600

- 2 x 12" (30 cm) Subwoofers
- 2" (50 mm) Voice Coils
- 600 Watts RMS/ 1200 Watts Max
- Impedance 4 Ohms
- 93 dB @ 1 watt/ 1 meter
- Aviation Grade Carpet with Logo-Embroidery
- 30" x 15.25" x 18.25"/10"

LOAD YOUR TRUNK

DUAL BASS REFLEX

GTR1002

- 2 x 10" (25 cm) Subwoofers
- 2" (50 mm) Voice Coils
- 500 Watts RMS/ 1000 Watts Max
- Impedance (2) 4 Ohms
- 92 dB @ 1 watt/ 1 meter
- Aviation Grade Carpet with Logo-Embroidery
- Red Metal Protection Bars
- 25.5" x 13" x 12.5"/10"
- Tuning Frequency 39Hz



GERMAN DESIGNED
GERMAN ENGINEERED



RENEGADE SUBBOXES/SUBWOOFERS



SINGLE BASS REFLEX

GT1200

- 12" (30 cm) Subwoofer with 12" (50 mm) Voice Coil
- 300 Watts RMS/500 Watts Max
- Impedance 4 Ohms
- 91 dB @ 1 watt / 1 meter
- Aviation Grade Carpet with Logo-Embroidery
- 15.25" x 14.25" x 13.5"/11.5"
- Tuning frequency 35Hz

10" SUBWOOFER

GTW1000

- 10" (25 cm) Subwoofer with 2" (50 mm) Voice Coil
- 250 Watts RMS/500 Watts Max
- Impedance 4 Ohms
- QTS .65
- FS 36 Hz
- 85 dB @ 1 watt / 1 meter
- Optimal Enclosure
 - Sealed 0.9ft³
 - Ported 1.2ft³ (1) 3" Round Port 8" Long
- Mounting Depth 4.5"
- Mounting Hole 9.25"



12" SUBWOOFER

GTW1200

- 12" (30 cm) Subwoofer with 2" (50 mm) Voice Coil
- 300 Watts RMS/600 Watts Max
- Impedance 4 Ohms
- QTS 0.46
- FS 32 Hz
- 85 dB @ 1 watt / 1 meter
- Optimal Enclosure
 - Sealed 1.4ft³
 - Ported 1.75ft³ (1) 4" Round Port 9" Long
- Mounting Depth 5"
- Mounting Hole 11"



RENEGADE SPEAKERS

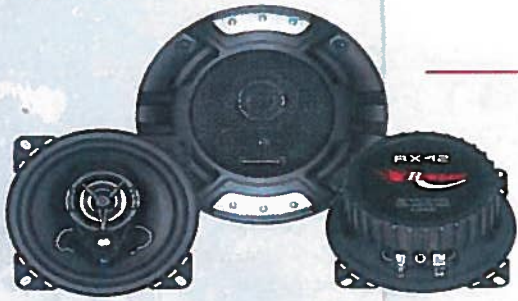

2-WAY SPEAKERS

RX42

- 4" (10 cm) 2-Way Full-Range Speakers
- 60 Watts RMS/ 120 Watts Max
- Impedance 4 Ohms
- Frequency Response 80 Hz - 20 KHz
- Mounting Depth 2"
- Mounting Hole 3.75"

BRING IT TO THE STREETS

2-WAY SPEAKERS

RX52

- 5.25" (13 cm) 2-Way Full-Range Speakers
- 80 Watts RMS/ 160 Watts Max
- Impedance 4 Ohms
- Frequency Response 65 Hz - 20 KHz
- Mounting Depth 2.25"
- Mounting Hole 4.5"

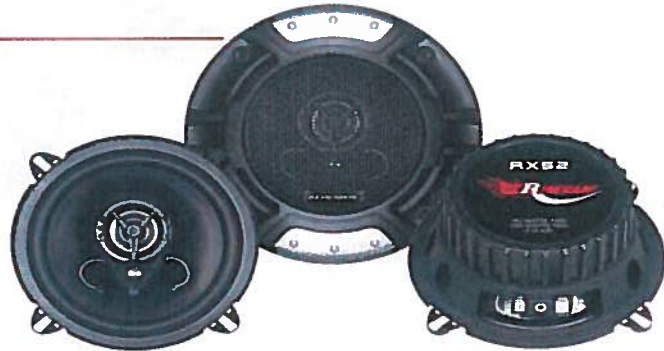

GERMAN DESIGNED
GERMAN ENGINEERED

2-WAY SPEAKERS

RX62

- 6.5" (16,5 cm) 2-Way Full-Range Speakers
- 100 Watts RMS/ 200 Watts Max
- Impedance 4 Ohms
- Frequency Response 60 Hz - 20 KHz
- Mounting Depth 2.25"
- Mounting Hole 5.625"

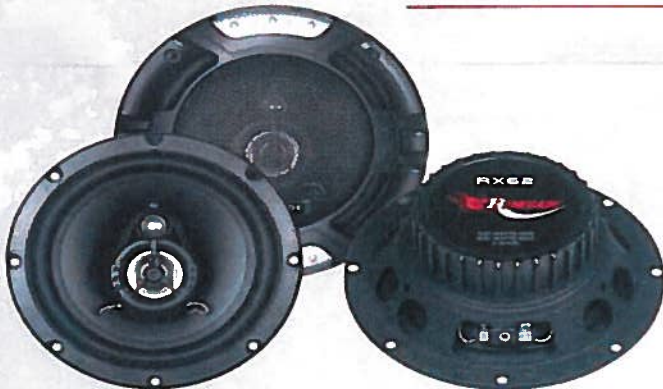



3-WAY SPEAKERS

RX693

- 6 x 9" 3-Way Full-Range System
- 150 Watts RMS/300 Watts Max
- Impedance 4 Ohms
- Frequency Response 50 Hz - 20 KHz
- Mounting Depth 3.25"
- Mounting Hole 6" x 8.625"

3-WAY SPEAKERS

RX830

- 8" (20 cm) 3-Way Full-Range System
- 150 Watts RMS/300 Watts Max
- Impedance 4 Ohms
- Frequency Response 45 Hz - 20 KHz
- Mounting Depth 3"
- Mounting Hole 7.125"



COMPONENT SYSTEM

RX6.2C

- 6.5" (16.5 cm) 2-Way Component System
- 100 Watts RMS/200 Watts Max
- Impedance 4 Ohms
- Capsuled In-line Crossover
- 20 mm Neodymium-Tweeter
- Frequency Response 60 Hz - 20 KHz
- Mounting Depth 2.25"
- Mounting Hole 5.625"





AMPLIFIER INSTALLATION KIT

REN35KIT

- 1 x 35 mm² (Apx 2ga) Power Wire (red), with flexible Strands (0,15 mm), 5 m
- 1 x 35 mm² (Apx 2ga) Ground Wire (grey), with flexible Strands (0,15 mm), 0.8 m
- 1 x RCA Stereo Audio Cable (blue), double shielded, 5 m
- 1 x 0.5 mm² Remote Wire, 5 m
- 1 x ANL Fuseholder with 150 A ANL Fuse



AMPLIFIER INSTALLATION KIT

REN20KIT

- 1 x 20 mm² (Apx 4ga) Power Wire (red), with flexible Strands (0,15 mm), 5 m
- 1 x 20 mm² (Apx 4ga) Ground Wire (grey), with flexible Strands (0,15 mm), 0.8 m
- 1 x RCA Stereo Audio Cable (blue), double shielded, 5 m
- 1 x 0.5 mm² Remote Wire, 5 m
- 1 x AGU Fuseholder with 60 A Fuse



AMPLIFIER INSTALLATION KIT

RENIOKIT

- 1 x 10 mm² (Apx 8ga) Power Wire (red), with flexible Strands (0,15 mm), 5 m
- 1 x 10 mm² (Apx 8ga) Ground Wire (grey), with flexible Strands (0,15 mm), 0.8 m
- 1 x RCA Stereo Audio Cable (blue), double shielded, 5 m
- 1 x 0.5 mm² Remote Wire, 5 m
- 1 x AGU Fuseholder with 40 A Fuse



POWER CAPACITOR

RX1200

- 1.2 Farad Capacity
- 4-digit Voltmeter Display
- Solid Acrylic Brackets



ALL BOXES ARE MADE FROM 3/4" MDF, SEALED AND WRAPPED IN DARK GREY CARPET

SPEAKER BOX ROUND DUAL

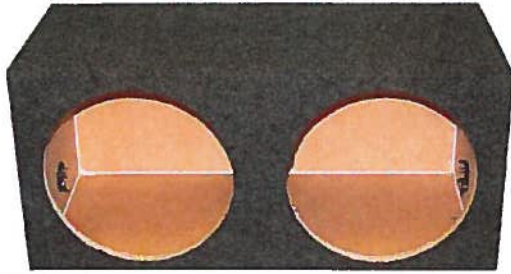

Part Number	Dimensions
SB2X10	12 X 12 X 24 Square
SB2X12	13 X 13 X 28 Square

SPEAKER BOX ROUND SINGLE

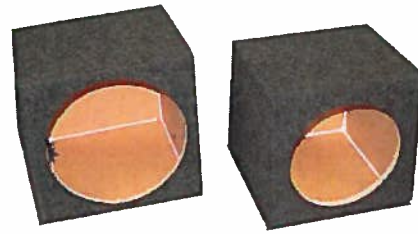

Part Number	Dimensions
SB1X10	12 X 12 X 12 Angle
SB1X12	13 X 13 X 13 Angle

TERMINAL CUPS ROUND AND SQUARE

Molded in terminals. Lever actuators. Heavy duty coil springs. No screws required. Overall size 2 1/16". Mounts in a 1 15/16" hole. Also available with Screw Holes.

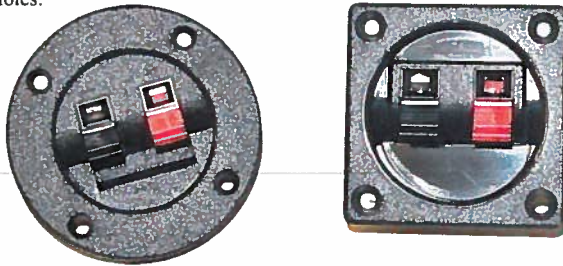

Part Number	Description
TA2	Square with Holes
TA3	Round Plain No Holes
TA3WH	Round With Holes
TA3 GOLD	Round Gold with Holes

SQUARE TERMINAL CUP WITH GOLD BINDING POSTS

Accepts up to 8 gauge speaker wires. 24 kt. gold plating for low loss.



Part Number
TA4

ROUND TERMINAL CUP WITH GOLD BINDING POSTS

Accepts up to 8 gauge speaker wires. 24 kt. gold plating for low loss.



Part Number
TA5

ABS / PLEXY SHEETS

ABS Textured black



Part Number	Thickness	Size
ABS1	1/8"	12" x 12"
ABS2	3/16"	12" x 12"
ABS3	1/16"	12" x 12"

IF YOU ARE LOOKING FOR SOMETHING SPECIAL CALL HAINES AND LET US KNOW. ALSO CHECK OUR WEBSITE FOR THE LATEST PRODUCT INFORMATION

METAL WOOFER GRILLS

(Hardware sold separately)

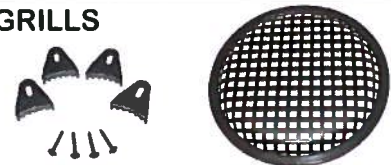

Part Number	Size
WG10	10"
WG12	12"
WGH	Hardware

12 VOLT COOLING FANS

Super quiet fan for all car audio cooling applications.

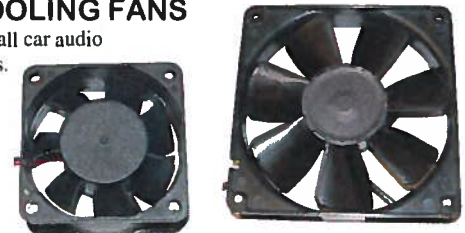

Part Number
FAN12
FAN12MINI

CAPACITORS NON POLARIZED

Better response for tweeters and mid-ranges.
100 volts.



Part Number	MFD
EC2.2	2.2
EC3.3	3.3
EC4	4
EC4.7	4.7
EC6	6
EC9.9	9.9
EC12	12
EC20	20
EC25	25
EC33	33
EC47	47
EC80	80
EC99	99
EC133	133
EC199/200	199

MYLAR CAPACITORS

Better response for tweeters and mid-ranges.
100 volts.



Part Number	MFD
MC22	2.2
MC33	3.3
MC47	4.7

FLOATING GROUND ADAPTER

Used to hook up a floating ground
(4 wire) output radio to an accessory
with common ground input (3 wire).



Part Number
FGA

SIGNAL NOISE ELIMINATOR & ADJUSTABLE OUTPUT REDUCER

Dual Channel
Full DC isolation
Adjustable Attenuation



Part Number
LOC100F/A

GROUND LOOP ISOLATOR

15 Amp High Quality Noise
Suppressor Isolation Transformer



Part Number
N34F

ALTERNATOR NOISE SUPPRESSER 5 AMP

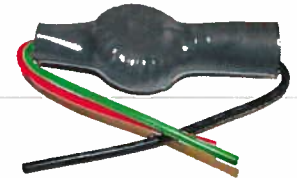

Part Number
N5IMP

ALTERNATOR NOISE SUPPRESSER 15 AMP



Part Number
N15IMP

NALTERNATOR NOISE SUPPRESSER 25 AMP



Part Number
N25IMP

LINE OUTPUT CONVERTER

Line output converters provide RCA outputs for low powered decks (i.e. factory decks). Converts common ground or floating ground output to low level outputs.



Part Number

LOC50M (RCA MALE)

AMP TURN OFF POP ELIMINATOR

Eliminates amplifier turn-off pop by breaking the signal path at the moment of turn off.



Part Number

N807

ADJUSTABLE LINE OUTPUT CONVERTER

Does everything that the LOC50s do but is also adjustable for precision left-right channel balancing.



Part Number

LOC100M (MALE RCA)

LOC100F (FEMALE RCA)

PULSE STRETCHER

(Trailing Edge Trigger) The N67 provides an adjustable timed +12 Volt output upon removal of a + or - voltage. Output is adjustable from 0.1 to 60 seconds. Use for amp turn off pop eliminator and other audio and alarm applications.



Part Number

N67

ADJUSTABLE DELAYED AMP TURN-ON

The N66 was designed to eliminate amplifier turn-on pops. The N66 will also work on alarm applications, window roll up or roll down, interior light delays, etc. To use as a Latching Relay Driver, use with a Bosch Relay.

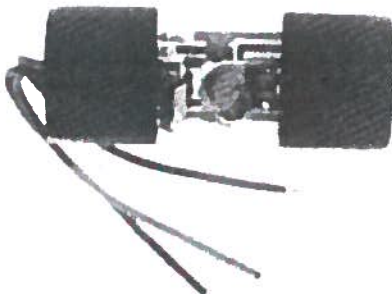

Part Number

N66A

PULSE STRETCHER

(Leading Edge Trigger) The N67A provides an adjustable timed +12 Volt output upon receipt of a + or -pulse. Output is adjustable from 0.1 to 60 seconds. Use for audio and alarm applications.



Part Number

N67A

N3 ALTERNATOR NOISE SUPPRESSER

The N3 is a 30 watt LC alternator noise filter for low powered decks and cassettes. 3 AMPS

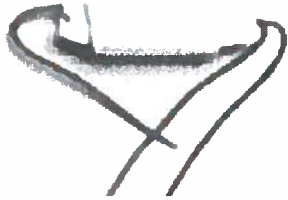

Part Number

N3

GROUND LOOP ISOLATOR & NOISE SUPPRESSER

The N344 is a small in-line low level noise decoupler which breaks signal path ground loops using 1:1 isolation transformers. Also decouples any DC offset voltage. This is the solution to stubborn alternator whine problems.



Part Number

N344

CD ELECTRONIC SWITCH

The N806 is used for pre-amp level switching between two head pieces, such as a compact disc player and an AM/FM cassette deck. The switching is done by using the electric antenna lead from either source.



Part Number

N806

CHOKE SUPPRESSER

Choke with ferrite core. Handles 10 amps.



Part Number

N5C

TORROID CHOKE

This torroid choke handles 25 amps. Wrapped in shrink tubing.



Part Number

N25T

ADJUSTABLE LINE ADAPTER/NOISE DECOUPLER

The N455 will create low level capability on high powered decks and other unusual impedance or other voltage signal problems. The N455 has full DC isolation to suppress noise and will adapt floating or bridged stereo outputs to a low level. Dual attenuation, full DC isolation, and easy installation make the N455 a top seller.

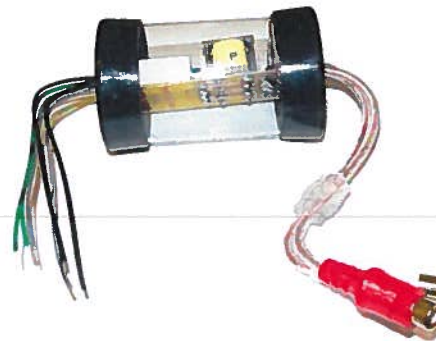

Part Number

N455

ELECTRONIC NOISE FILTERS

These filters use active elements to eliminate in-line noise from car stereo systems. The N500 eliminates alternator and generator whine, as well as some radio frequency in-line noise. The N600 should be used on larger amplifiers for active filtering. The N700 uses a broad band radio frequency trap to shunt high frequency ground noise.

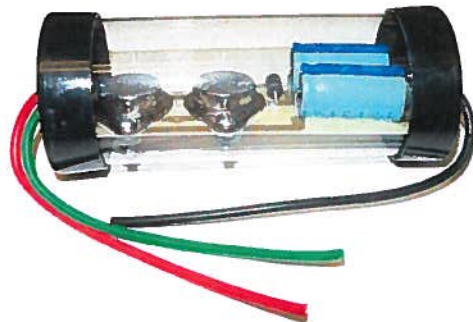

Part Number	Amps
N500	10
N600	25
N700	35



METRA TURBOWIRE



METRA TURBOKITS

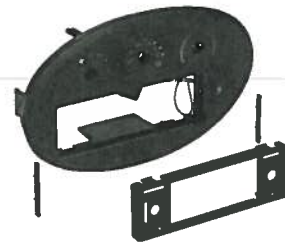

METRA ANTENNA ACCESSORIES



**We offer the most popular
Harnesses, Kits, Antenna's and other
audio accessories just give us a call and
let us know what you want it's a good bet
that we will have what your looking for.**

ANTENNA EXTENSIONS

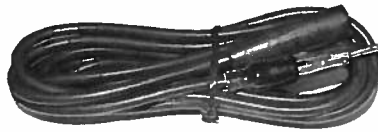

Part Number	Description
CR12	1 foot
CR24	2 feet
CR36	3 feet
CR48	4 feet
CR72	6 feet
CR96	8 feet
CR144	12 feet
CR180	15 feet

CHRYSLER ADAPTER

universal Female.



Part Number

CHRY1

CHRYSLER ADAPTER

universal Female.



Part Number

CHRY2

GM ADAPTER

Fits GM 1988-93.
"Mini" female to universal male.



Part Number

GM1

GM ADAPTER

Fits GM 1988-93 "Mini" female to universal male.



Part Number

GM2

NISSAN DIVERSITY ADAPTER

Two pole female to universal male.



Part Number

NIS1

MOTOROLA ANTENNA "Y" CONNECTOR



Part Number

MF2

Description

1 male to 2 female

MM2

2 male to 1 female

FORD ADAPTERS

Ford factory antenna to aftermarket radio.



Part Number

FD1

FORD ADAPTERS

Ford factory radio to aftermarket antenna



Part Number

FD2

VW/AUDI ADAPTER



Part Number

VW1

VW2

MOTOROLA MALE ANTENNA PLUG

Solder on.



Part Number

MAP

NISSAN DIVERSITY ADAPTER

Two pole male to universal female.



Part Number

NIS2

POWER ANTENNA - FULLY AUTOMATIC



Part Number

44-PW22

44-PW20 - W/5 MOUNTING HEADS



LIGHTS HID AND REPLACEMENT



Part Number	Colors	Part Number	Colors
36LWU	HI POWER FESTOON LED WHITE	1157WK	BULB - 1157 - SUPER WHITE
36LBU	HI POWER FESTOON LED BLUE	1157LYH	1157 - SUPER BRIGHT LED YELLOW
31LWU	HI POWER FESTOON LED WHITE	1157LWV	1157 360 LED BULB SUPER WHITE
31LBU	HI POWER FESTOON LED BLUE	1157LWH	1157 - SUPER BRIGHT LED SUPER WHITE
3157WK	3157 - HALOGEN - SUPER WHITE	1157LRH	1157 - SUPER BRIGHT LED RED
3157LWI	3157 LED CLEAR	1157LGH	1157 - SUPER BRIGHT LED GREEN
3157LRI	3157 LED RED	1157LED-W	SINGLE 1157 LED - WHITE
3157LED-W	SINGLE 3157 LED - WHITE	1157LED-R	SINGLE 1157 LED - RED
3157LED-R	SINGLE 3157 LED - RED	1157LED-HP-W	1157 HIGH POWER LED - WHITE
3157LED-HP-W	3157/3156 HIGH POWER LED	1157LED-A	SINGLE 1157 LED - AMBER
3157LED-A	SINGLE 3157 LED - AMBER	1157LBH	1157 - SUPER BRIGHT LED BLUE
3157LAI	3157 LED AMBER	1157LAV	1157 360 LED BULB AMBER
3156WK	3156 - HALOGEN - SUPER WHITE	1157LAH	1157 - SUPER BRIGHT LED AMBER
3156LWI	3156 LED CLEAR	1156WK	BULB - 1156 - SUPER WHITE
3156LRI	3156 LED RED	1156LYH	1156 - SUPER BRIGHT LED YELLOW
3156LED-W	SINGLE 3156 LED - WHITE	1156LWV	1156 360 LED BULB SUPER WHITE
3156LED-R	SINGLE 3156 LED - RED	1156LWH	1156 - SUPER BRIGHT LED SUPER WHITE
3156LED-A	SINGLE 3156 LED - AMBER	1156LRH	1156 - SUPER BRIGHT LED RED
3156LAI	3156 LED AMBER	1156LGH	1156 - SUPER BRIGHT LED GREEN
3057LWV	3057 360 LED BULB SUPERWHITE	1156LED-W	SINGLE 1156 - LED - WHITE
3057LAV	3057 360 LED BULB AMBER	1156LED-R	SINGLE 1156 LED - RED
3056LWV	3056 360 LED BULB SUPERWHITE	1156LED-HP-W	1157 HIGH POWER LED - WHITE
3056LAV	3056 360 LED BULB AMBER	1156LED-A	SINGLE 1156 LED - YELLOW
194WK	194 - HALOGEN - SUPER WHITE	1156LBH	1156 - SUPER BRIGHT LED
194RK	194 - HALOGEN - RED	1156LAV	1156 360 LED BULB AMBER
194PK	194 - HALOGEN - PURPLE	1156LAH	1156 - SUPER BRIGHT LED AMBER
194LYK	194 - LED - YELLOW	921LED-W	PAIR 921 - LED - WHITE
194LWV	194 - LED - WHITE- 360°	921LED-R	PAIR 921 - LED - RED
194LWU	194 - LED - WHITE	921LED-B	PAIR 921 - LED - BLUE
194LWK	194 - LED - WHITE	921LED-A	PAIR 921 - LED - AMBER
194LRK	194 - LED - RED	7443WK	7443 - HALOGEN - SUPER WHITE
194LGK	194 - LED - GREEN	H7443SW	BULB - 7443 - SUPER WHITE
194LED-W	PAIR - 194 LED - WHITE	7443LWV	7443 360 LED BULB
194LED-HP-W	194 HIGH POWER LED - WHITE	7443LWI	7443 LED CLEAR
194LED-HP-R	PAIR - 194 LED - RED	7443LED-W	PAIR - 7443 LED - WHITE
194LED-HP-B	194 HIGH POWER LED - BLUE	7443LED-R	PAIR - 7443 LED - RED
194LED-HP-A	PAIR - 194 LED - AMBER	7443LED-HP-W	7443/7440 HIGH POWER LED
194LED-B	PAIR - 194 LED - BLUE	7443LED-A	PAIR - 7443 LED - AMBER
194LBU	194 - LED - BLUE	7440WK	7440 - HALOGEN - SUPER WHITE
194LBK	194 - LED - BLUE	H7440SW	BULB - 7440 - SUPER WHITE
194LAV	194 - LED - AMBER	7440LWI	7440 LED CLEAR
194BK	194 - HALOGEN - BLUE	7440LED-W	PAIR - 7440 LED - WHITE
		7440LED-R	PAIR - 7440 LED - RED
		7440LED-A	PAIR - 7440 LED - AMBER
		7440LBI	7440 LED BLUE



LIGHTS HID AND REPLACEMENT



HID KITS

KE - Series - Large Ballast - Bulbs 880, 9004/7, 9005, 9006, H1, H4, H7, H10, H11 and H13-6K or 8K

KES - Series - Slim Ballast - Bulbs 880, 9004/7, 9005, 9006, H1, H4, H7, H10, H11 and H13-6K or 8K

Other colors are available

We have BI-XENON and Motorcycle Kits



Part Number

KE - 880, 9004/7, 9005, 9006, H1, H4, H7, H10, H11 and H13 - 6K or 8K

KES - 880, 9004/7, 9005, 9006, H1, H4, H7, H10, H11 and H13 - 6K or 8K

LIMITED LIFETIME WARRANTY

- ° Brighter light for better vision and notice ability.
- ° H.I.D effect and color temperature Xenon filled for long life and high light output.
- ° Ultra U.V. Block glass suitable for plastic headlamps



Type	H9004	H9005	H9006	H9007
Super White 55WT	H9004SW	H9005SW	H9006SW	H9007SW
Super White 12v - 65w		IN-9005L5	IN-9006L5	IN-9007L5
		IN-9005XSLS	IN-9006XSLS	

H1	H3	H4	H7	H9	H10	H11	H13	893
H1SW	H3SW	H4SW	H7SW					
	IN-H3L5	IN-H4L5	IN-H7L5	IN-H9L5	IN-H10L5	IN-H11L5	IN-H13L5	IN-893L5
	IN-H3L5G				IN-H11L5G			

MINI-MOTION LED BARS

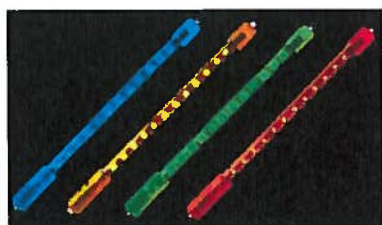

Part Number	Description
VIS-HILM6R	Mini motion LED 6" pair w/ sound (twin pack) Red
VIS-HILM6P	Mini motion LED 6" pair w/ sound (twin pack) Purple
VIS-HILM6M	Mini motion LED 6" pair w/ sound (twin pack) Multi color
VIS-HILM6G	Mini motion LED 6" pair w/ sound (twin pack) Green
VIS-HILM6B	Mini motion LED 6" pair w/ sound (twin pack) Blue
VIS-HILM12R	Mini motion LED 12" pair w/ sound (twin pack) Red
VIS-HILM12P	Mini motion LED 12" pair w/ sound (twin pack) Purple
VIS-HILM12M	Mini motion LED 12" pair w/ sound (twin pack) Multi color
VIS-HILM12G	Mini motion LED 12" pair w/ sound (twin pack) Green
VIS-HILM12B	Mini motion LED 12" pair w/ sound (twin pack) Blue
VIS-HILFM6W	LED 6" - 2 TUBE FLEX MOTION - WHITE
VIS-HILFM6R	LED 6" - 2 TUBE FLEX MOTION - RED
VIS-HILFM6P	LED 6" - 2 TUBE FLEX MOTION - PURPLE
VIS-HILFM6M	LED 6" - 2 TUBE FLEX MOTION - MULTI-COLOR
VIS-HILFM6G	LED 6" - 2 TUBE FLEX MOTION - GREEN
VIS-HILFM6B	LED 6" - 2 TUBE FLEX MOTION - BLUE
VIS-HILFM12W	LED 12" - 2 TUBE FLEX MOTION - WHITE
VIS-HILFM12R	LED 12" - 2 TUBE FLEX MOTION - RED
VIS-HILFM12M	LED 12" - 2 TUBE FLEX MOTION - MULTI-COLOR
VIS-HILFM12G	LED 12" - 2 TUBE FLEX MOTION - GREEN
VIS-HILFM12B	LED 12" - 2 TUBE FLEX MOTION - BLUE

POWER DISTRIBUTION BLOCK
 24 kt gold plating. Acrylic cover.
 One 4-8 gauge cable in, four 8-12 gauge cables out.



Part Number

ME521A

4 POSITION AGU FUSE BLOCK

Accepts up to three 4 gauge cables in, four 8 gauge cables out.
 For AGU fuses. 24 kt gold plating.



Part Number

ME524A

3 POSITION AGU FUSE BLOCK

One 4 gauge cable in, three 8 gauge cables out. 24 kt gold plating.



Part Number

ME525B

2 POSITION AGU FUSE BLOCK

One 4 gauge cable in, two 8 gauge cables out. 24 kt gold plating.



Part Number

ME526B

AGU FUSE HOLDER

4 AWG or 0 AWG Power Cable
 Water Proof



Part Number

ME27

ANL FUSE HOLDER 4 AWG



Part Number

ME541

ANL FUSE HOLDER 4 AWG OR 0 AWG POWER CABLE Connection



Part Number

ME539

GOLD RINGS

Black and Red.
 24 kt hard gold finish.
 High temperature,
 Soft PVC insulators.



Part Number	Gauge	Size
GR810B	8	#10
GR810R	8	#10
GR856B	8	5/16"
GR856R	8	5/16"
GR838B	8	3/8"
GR838R	8	3/8"
GR410B	4	#10
GR410R	4	#10
GR456B	4	5/16"
GR456R	4	5/16"
GR438B	4	3/8"
GR438R	4	3/8"
GR256B	2	5/16"
GR256R	2	5/16"
GR238B	2	3/8"
GR238R	2	3/8"
GR056B	0	5/16"
GR056R	0	5/16"
GR038B	0	3/8"
GR038R	0	3/8"

GOLD SPADE TERMINALS

Narrow configuration to fit in tight places. i.e. amps, barrier strips, etc. 24 kt hard gold finish.
 High temperature soft PVC insulators.



Part Number	Gauge	Size
GS88B	8	#8
GS88R	8	#8
GS810B	8	#10
GS810R	8	#10
GS408B	4	#8
GS408R	4	#8
GS410B	4	#10
GS410R	4	#10



BATTERY TERMINALS



GOLD POWER RINGS

24 kt gold plated terminal can be used with our ME528 battery terminals.



Part Number	Gauge
ME40602	2
ME40604	4
ME40608	8
ME40600	0

GOLD TOP MOUNT BATTERY TERMINAL

24 kt gold plating. Main power connection up to 4 gauge. Two auxiliary outputs up to 8 gauge.



Part Number	Description
ME528P	Positive(+)
ME528N	Negative(-)

GOLD BATTERY DISTRIBUTION TERMINALS

24 kt gold plating. One 1/0 gauge, two 4 gauge, and two 8 gauge inputs.



Part Number	Description
ME535BP	Positive(+)
ME535BN	Negative(-)
CC535	Clear Rubber Cover

PLATINUM POSITIVE & NEGATIVE BATTERY TERMINAL



Part Number	Description
TY-10PP	Positive Terminal
TY-10PN	Negative Terminal

PLATINUM POSITIVE & NEGATIVE BATTERY TERMINAL



Part Number	Description
TY-12PP	Positive Terminal
TY-12PN	Negative Terminal

Battery Terminals 6-00 Gauge



888L 999L

862L

Part Number	Description
888L	Top Mount
999L	Side Mount
862L	Marine Type

Battery Post Extenders



Part Number	Description
HW13	Side Post
HW13L	Long side post
HW13 Gold	Side Post
HW13L Gold	Long side post

Quick Connect Terminal



Part Number	Description
884L	Battery Switch
885L	Side Post Adapter

PLATINUM AND GOLD UN-FUSED

One 0 AWG to Four 4 AWG and Four 8AWG With Clear See-Thru Design



Part Number
TY-4

PLATINUM AND GOLD UN-FUSED

Distribution Block One 4 AWG to Four 8 AWG With Clear See-Thru Design



Part Number
TY-1

SUPER SWITCH

Polycarbonate plunger, Stainless steel spring
Nickel plated body.



Part Number

7846SS

FLANGE MOUNT PIN SWITCH

Tough poly carbonate ribbed plunger.
Custom cut to any length. Stainless steel spring.
Rust proof.



Part Number

7844

RUBBER BOOTED PIN SWITCH

Eurostyle. Waterproof. Polycarbonate plunger.
Stainless steel spring.



Part Number

7848

VERTICAL FLANGE MOUNT PIN SWITCH

Polycarbonate shaft. Custom Cut.
Great underhood versatility.



Part Number

7850

SELF TAPPING PIN SWITCH

Available in long or short version.



Part Number

Size

7001S

1 15/16"

7001L

2 1/2"

MERCURY TYPE PIN SWITCH

15 degree trigger.



Part Number

MTP

ZERO CLEARANCE PIN SWITCH

Adjustable short switch. Ideal for tight places.



Part Number

7000

FLAT PIN SWITCH BRACKET



Part Number

PSB

RIGHT ANGLE PIN SWITCH BRACKET



Part Number

PSB90

SLIDING DOOR CONTACT



Part Number

SDL15

**IF YOU ARE LOOKING FOR
SOMETHING SPECIAL CALL HAINES
AND LET US KNOW ALSO CHECK
THE WEBSITE FOR THE LATEST
PRODUCT INFORMATION**

MINI MAGNETIC REED SWITCH

Normally open. 12" leads.
Screw and adhesive mounting.



Part Number

MMR42

HEAVY DUTY FLASHER

Flasher made in U.S.A.



Part Number

552

AUDIBLE BEEPER

Works with most alarms.



Part Number

AB6

CARBON FILM RESISTOR

1/4 WATT 5%



CFR1.0K OHM	CFR110 OHM	CFR30 OHM	CFR5.1K OHM
CFR1.2K OHM	CFR150 OHM	CFR330 OHM	CFR510 OHM
CFR1.3K OHM	CFR180 OHM	CFR390 OHM	CFR560 OHM
CFR1.5K OHM	CFR2.7K OHM	CFR3K OHM	CFR620 OHM
CFR1.6K OHM	CFR240 OHM	CFR4.7K OHM	CFR7.5K OHM
CFR1.8K OHM	CFR270 OHM	CFR430 OHM	CFR820 OHM
CFR10 OHM	CFR2K OHM	CFR470 OHM	CFR9.1K OHM
CFR100 OHM	CFR3.9K OHM	CFR47K OHM	CFR910 OHM

Part Number	Description
CFR (Value)	CFR Resistor Specify Value 20 Pack
CFR-KIT	Most Popular Values See Chart (In Shade) in box

POWER DIODE

Restricts direction of current.
Use for ignition kill, flashing lights, etc.



Part Number	Size
P1	1 amp
P3	3 amp
P6	6 amp

BOSCH RELAY

"Mini-Giant" relays. 30 amp. 12 Volt DC.
SPDT # 0332204150.



Part Number

BR033

HELLA RELAY

Mini 20/40 AMP SPDT
12V 20/40A



Part Number

HR1

ECONOMY RELAY

An economical and reliable relay.
SPDT 30 to 40 amp 12 Volt DC.



Part Number

ER1

STARTER KILL RELAY SOCKET

A diode is pre-wired for ignition or starter kill.
Easy three wire hookup. 18" wire leads.



Part Number

RH3

DUAL SOCKET RELAY HARNESS

Pre-wired for all types of door locks.



Part Number

RH2D

DELUXE RELAY HARNESS

Three 14 gauge and two 18 gauge wires.



Part Number

RH2-12

RH2-18

RH2-24

Size

12"

18"

24"

LED'S

Plastic Housing. Pre-Wired.
Flashing or steady.



Part Number	Description
LED1	Steady
LED2	Flashing

12 VOLT ALKALINE BATTERY SOLD IN PACKS OF 5

Used in most remote transmitters. Retail packaged. Guaranteed quality.



Part Number
BAT9 (910AMP 1.5V NCELL)
BAT/AAA (TRIPLE A BATTERY, 2/CARD)
GP23 (ALKALINE - 12v)
GP27A (SLIM - ALKALINE - 12v)

LITHIUM BATTERY SOLD IN PACKS OF 5

Button Cell.



Part Number	Description
LIT-CR1220	Lithium Button cell 1220
LIT-CR1616	Lithium Button cell 1616
LIT-CR2016	Lithium Button cell 2016
LIT-CR2025	Lithium Button cell 2025
LIT-CR2032	Lithium Button cell 2032
LIT-CR2450	Lithium Button cell 2450
LIT-CR2477	Lithium Button cell 2477
LIT-LR41	Lithium Button cell 392

WINDOW ROLL UP MODULE

Closes two windows simultaneously when alarm is activated. Only engages when windows are down. For safety the system will disengage if window meets resistance.
Made in U.S.A. Lifetime warranty.



Part Number
ME300

BATTERY BACKUP SIREN

Loud 129 dB. Siren sounds if main power input is disconnected. Includes key switch override. 1.2 amp.



Part Number
BS400

TRUNK RELEASE SOLENOID

Add remote trunk/hatch release to any vehicle. Use with any alarm with second channel output. Complete with hardware and switch



Part Number
TR100

DOOR-POP STAINLESS STEEL



Part Number
DOOR POP

HEAVY DUTY TRUNK RELEASE

35LBS Rating.



Part Number
TR101

ECONO DOOR LOCK ACTUATORS

Converts manual lock mechanism to electronic activation. All hardware included.



Part Number
GF230

NEW & IMPROVED DOOR LOCK ACTUATORS

Converts manual lock mechanism to electronic activation. All hardware included.



Part Number
GF330

DOOR LOCK ACTUATORS HEAVY DUTY SLIM CLUTCH TYPE

Converts manual lock mechanism to electronic activation. All hardware included.

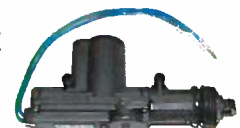

Part Number
GF430

MINI PIEZO SIREN

Small size for interior use. Pain generating siren. 110 dB.



Part Number
MPS1

The Fits-All™ mount

UNIVERSAL AUTOMOTIVE ELECTRONICS MOUNTING BRACKET

The Fits-ALL™ mount is a UNIVERSAL, INSTALLER MODIFIABLE, NO VISIBLE HOLES, in-the-DASH ACCESSORY MOUNTING BRACKET!

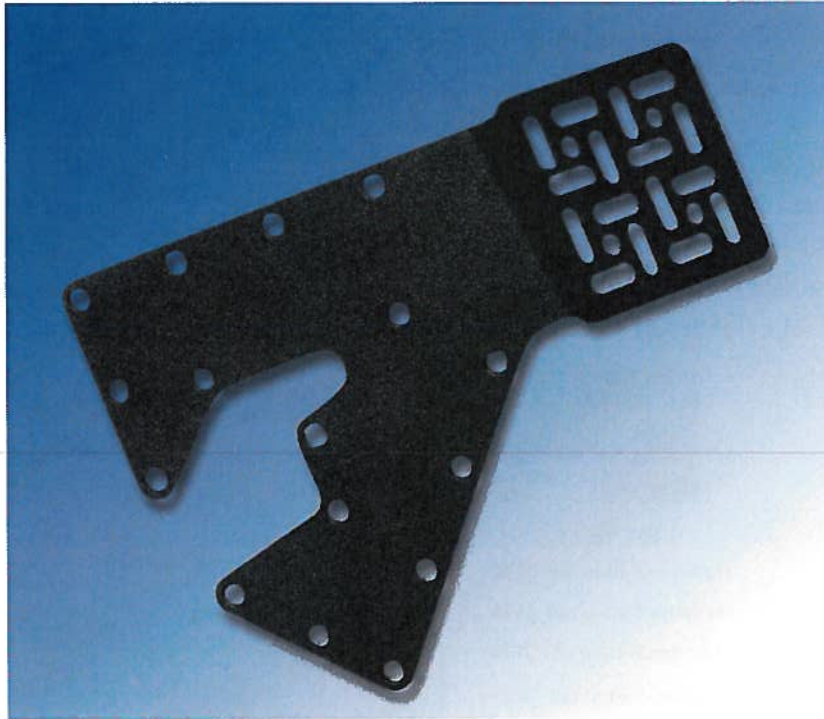

One Mount, One *SKU*, Fits-All™!



GPS NAV. UNITS



PDA,S



CELL PHONES



MP3,S



SATELLITE RADIOS

- Install a **SECOND DASH MOUNTED DEVICE!**
- Don't lose the sale, **INSTALL IT TODAY!**
- Put the **UNIT** where your **CUSTOMER WANTS IT!**
- **\$\$ LOWER PRICE** than the dash-specific mounts!
- **8 Way ORIENTATION!**
- Same day installation at **LOWER HARDWARE COST!**

- **WORKS** with **ANY VEHICLE!**
- The right mounting bracket is **ALWAYS IN STOCK!**
- No expensive, **RUSH OVERNIGHT** orders!
- **Lifetime Warrantee!**
- **PATENTED!**
- **100% MADE IN THE USA!**

Part Number

FITSALL



CELLULAR IN DASH MOUNTS



INDASH Mounts

Custom designed to fit specific vehicles including the latest models cars, trucks, sport utility vehicles and vans. They are widely used to mount hands free kits, 3-Watt booster kits and GPS units

For part number call the factory or visit the website.

- ACURA
- AUDI
- BMW
- BUICK
- CADILLAC
- CEVROLET
- CHRYSLER
- DODGE
- EAGLE
- FORD
- GEO
- GMC
- HONDA
- HUMMER
- HYUNDAI
- INFINITI
- ISUZU
- JAGUAR
- JEEP
- KIA
- LEXUS
- LINCOLN
- MAZDA
- MERCEDES BENZ
- MERCURY
- MITSUBISHI
- NISSAN
- OLDSMOBILE
- PLYMOUTH
- PONTIAC
- PORSCHE
- SAAB
- SATURN
- SUBARU
- SUZUKI
- TOYOTA
- VOLKSWAGEN
- VOLVO





PANAVISE CELLULAR / VIDEO MOUNTS



EXTENSION BRACKET



Part Number	Description
PAN768	Fit all Indash Mount

EXTENSION BRACKET

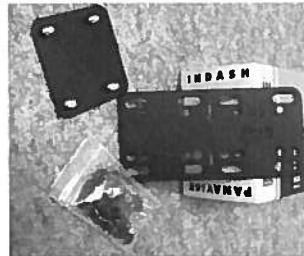

Part Number	Description
PAN767-04	4" for INDASH
PAN767-05	5" for INDASH

VIDEO SCREEN & GPS MOUNT

T-Bolt Mount



Part Number
PAN651-IDTS

VIDEO SCREEN & GPS MOUNT

For 1/4-20 Thread

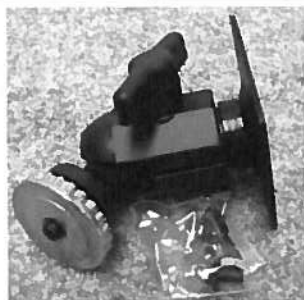

Part Number
PAN651-IDS

IF YOU ARE LOOKING FOR SOMETHING SPECIAL CALL HAINES AND LET US KNOW ALSO CHECK OUR WEBSITE FOR THE LATEST PRODUCT INFORMATION

T-BLOT UNIFLEX MOUNT

with 360 degree Ball Mount for Video Screen & GPS



Part Number
PAN697-12
PAN697-14

UNIFLEX MOUNT

with 360 degree Ball Mount for Video Screen & GPS



Part Number
PAN797-12
PAN797-14

1/4-20 THREAD UNIFLEX MOUNT

with 360 degree Ball Mount for Video Screen & GPS

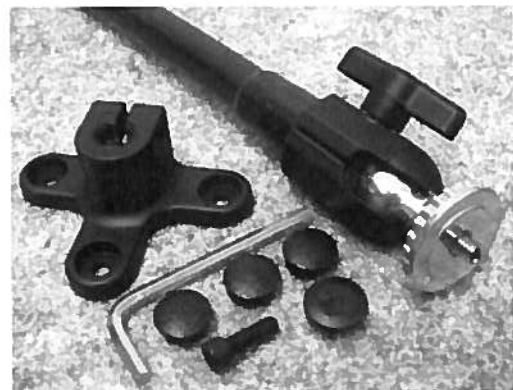

Part Number
PAN817-13
PAN817-16



CELLULAR & VIDEO MOUNTS



TIPPERS

Add user adjustability to any Installation quickly and easily! Features Users can easily position and reposition their electronics (30° tilt in any direction and 360° rotation), Smooth adjusting action holds electronics firmly in place. Interfaces between any AMPS Compatible phone mount and mobile electronics device (mounting hardware included). Extends approximately 1.5" (38.1 mm) from the base of the mount



Part Number	Description
PAN685-PM	AMPS Tipper (AMPS to AMPS)
PAN685-S	1/4-20 Stud Tipper (AMPS to 1/4-20 Female Thread)
PAN685-TS	T-Bolt Tipper (AMPS to T-Slot)

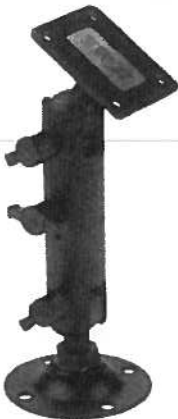

PEDESTAL MOUNTS

- ◆ Includes both allen screw and thumb screw fasteners.
- ◆ Aircraft grade aluminum construction.
- ◆ Teflon coated fasteners that won't loosen.
- ◆ Tough polyurethane enamel finish.
- ◆ Made in U.S.A.

Part Number	Description
104T	4" Standard
106TS	6" Slim
106T	6" Standard
108T	8" Standard
110T	10" Standard



DELUXE VINYL CLAD FLEX MOUNTS

Our most popular mount, now available in more sizes.
Flexible gooseneck. Body is neatly wrapped in vinyl. Great looking mount!
Made in U.S.A. Lifetime warranty.

Part Number	Description
107VFM2	7" Vinyl Clad
109VFM2	9" Vinyl Clad
111VFM2	11" Vinyl Clad
113VFM2	13" Vinyl Clad
115VFM2	15" Vinyl Clad

Cigarette Lighter socket with
Right angle steel mounting
bracket .250 terminal tabs, dust cap.
Black faceplate.
(for accessories, not lighters)



Part Number

CL-AS203B

DOUBLE FEMALE "Y" ADAPTER

Allows user to
operate phone
and one
additional accessory.

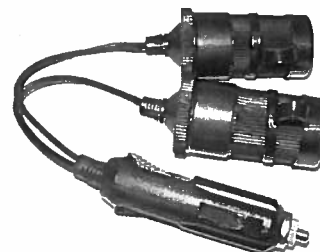

Part Number

BDF

CIGARETTE LIGHTER PLUG WITH 6' HEAVY DUTY 16-GAUGE WIRE AND A 3 AMP FUSE



Part Number

CL-AP101

CIGARETTE LIGHTER PLUG ONLY



Part Number

CL-AP106

CIGARETTE LIGHTER W/ 2A FUSE



Part Number

CL-AP110

CIGARETTE 3 WAY W/PLUG & 3 ft WIRE



Part Number

CL-AP116

CIGARETTE LIGHTER BLANK



Part Number

CL-AS201

CIGARETTE LIGHTER WITH 8" , 16 Ga. WIRE



Part Number

CL-AS2018



BLUEFUSION HANDS FREE



BLUEFUSION

HANDS FREE CELLULAR & STREAMING AUDIO TO FACTORY STEREOS

BLUEFUSION seamlessly integrates any BLUETOOTH enabled cellphone into the factory audio system of select GM, Honda, and Toyota vehicles. It is the ultimate hands-free Bluetooth car kit

PLAYS CALLS THROUGH THE FACTORY STEREO SYSTEM - CALLER ID DISPLAYS ON SCREEN - ANSWER AND HAND-UP BUTTONS LOCATED ON THE STEERING WHEEL AND STEREO - DSP ECHO CANCELLATION ENSURES A CRYSTAL CLEAR CONVERSATION - AUTOMATICALLY PAIRS WITH YOUR PHONE WHEN POWERED ON - VOICE DIALING WITH COMPATIBLE PHONES - INCLUDES HANDS-FREE MICROPHONE, FACTORY T-HARNESS AND ALL THE NECESSARY MOUNTING HARDWARE - INSTALLS IN MINUTES WITHOUT CUTTING OR SPLICING FACTORY WIRING - COMPATIBLE WITH A2DP STREAMING AUDIO DEVICES (Harness required)



Part Number: BFGM
BlueFusion for select GM Vehicles



Part Number: BFCL2
BlueFusion for select GM Class 2 Vehicles 2000 - UP



Part Number: BFHA
BlueFusion for select HONDA Vehicles



Part Number: BFTA
BlueFusion for select TOYOTA Vehicles



Part Number: BFEC
BlueFusion for select ECLIPSE Vehicles

HANDSFREE



CBHV - callBOX

Bluetooth cellular hands-free visor mount Works with most Bluetooth cell phones Easily accessible integrated microphone and speaker Built-in rechargeable Li-ion battery Adjustable volume control Call answer/hang-up buttons Volume control Car power plug for charging battery...



CBHV5 - chitCHAT

The chitCHAT Bluetooth speakerphone clips directly to your vehicles visor. A high output speaker combined with DSP echo cancellation software ensures a clear conversation even in the noisiest vehicles. The adjustable caller ID screen shows who is calling, battery life, pair status and much more. - Bluetooth 2.0 - DSP echo cancellation - 10 hours talk time, 600 hours standby - Includes car charger and USB cable for home charging...



CBHR - hearSAY

Bluetooth wireless headset for most Bluetooth phones Car docking station for speaker phone and charging Headset has built-in rechargeable Lithium-ion battery Dock headset into charger for hands-free speaker phone use Built-in microphone & speaker No external battery or AC power adapter required Adjustable volume control Call answer/hang-up button USB charging cable for ear piece included



BTHS - jabberJAW

-Answer Bluetooth® phone calls through your earpiece -includes USB charging cable and car adapter -1.2 Bluetooth® compliant -Crystal clear sound quality -300 hours of standby time and 10 hours of talk time -Voice dialing and redialing with most Bluetooth cellular phones ...



DIYBRH - motorMOUTH

This "plug and play" Bluetooth receiver plays cellular calls through your speakers, so you can keep your eyes on the road and hands on the wheel. The motorMOUTH plugs directly into the MP3/AUX input found in most new vehicles and aftermarket stereos. 2008 CES Innovations Award Winner...

POWER



IFWA
(passPORT)

CONNECTIVITY



IPUSBK

ON THE ROAD



IUFMD

IFWA	USB Charging Adapter (passPORT)
IFWAHW	USB Charging Adapter for Home (White)
IFWAHBK	USB Charging Adapter for Home (Black)
IPCRC	12v Retractable Car Charger for iPod
IPCHRG2	12v Car Charger for iPhone
USB12VFL	USB female plug with Flashlight to 12v Cig lighter
USB12V2	Dual USB female plug to 12v Cig lighter
IP3IN1	iPod charger car (dual input) & home
IP2IN1	iPod charger car & home
IU2PS	Universal Twin Socket Adapter
IPPWR	IPOD Home Charger
DUSBH	Home Dual USB Charger
IUPWR	IPOD international Power Adapters
IPHCBK	iPod Home Charger with Nightlight (Black case)
IPHCH	iPod Home Charger with Nightlight (White case)
IBAT2	Backup battery and Charger for iPod
IBAT3	Backup battery and Charger for iPod
SOLBAT	Solar Powered Backup battery and Charger for iPod
IBAT	Battery Pack for iPod
IPAV	iPod to Composite Audio / Video cables
IPAVRGB	HD audio/video output for iPod and iPhone
I3RCA35V	3.5mm to RCA/Video cable (3 ft.)
I6RCA35V	3.5mm to RCA/Video cable (6 ft.)
I3RCA35A	3.5mm to RCA cable (3 ft.)
I6RCA35A	3.5mm to RCA cable (6 ft.)
IPUSBK	2.0 USB Cable (Black)
IPUSB	2.0 USB Cable
MUSB	USB to mini USB cable
MUSBR	USB to mini USB cable (RETRACTABLE)
I335	3.5mm to 3.5mm plug cable (3 ft.)
I635	3.5mm to 3.5mm plug cable (6 ft.)
IP335	iPhone 3.5mm to 3.5mm plug cable (3 ft.)
IP635	iPhone 3.5mm to 3.5mm plug cable (6 ft.)
IU3.5RC	3.5mm retractable cable
IUHPS	3.5mm Headphone splitter
IU335K	Universal Audio Adapter kit
AXIPCL2	Select 2000 - up GM Class 2 iPod / RCA Input
AXIPGMLAN	Select 2007 - up GM LAN iPod / RCA Input to factory radio
AXIPHA	2004 - Up Select Honda iPod integration
AXIPTA	2005 - Up Select Lexus / Toyota / Scion / iPod Integration
FMTD2	Wireless FM Transmitter with Digital Display
FMTD1	Gear Shift style FM Transmitter with Digital Display
FMT1	Gear Shift style FM Transmitter
FMTD3	Goose neck FM Transmitter with Digital Display
FMTD4	FM Transmitter
FMTD6	FM Transmitter and USB Charger
FMTRNS01	FM Transmitter for MP3s and Auxillary Input Devices
IUFMD	Digital FM Transmitter for iPod/MP3 players; charges iPod
PCA1	Cassette Adapter for iPod / MP3 & other audio players
IPNRFCS	Wireless car and sport RF Remote control
IUH2	Vent mount Accessory holder
IPH35	Vent mount Accessory holder (Includes iPhone 3.5mm cable)
IPH12V	Universal Charging mount
IPH3G	Universal Vent and Windshield mounting kit



LISTEN



HZ5	Bluetooth Headphones
TZ4	Bluetooth Transmitter for iPod and iPhone
IUBTT	Bluetooth Transmitter for Universal MP3 Players
IDR600	Premium Increased Dynamic Range Earphones
IDR400M	Deluxe Increased Dynamic Range Earphones w/ mic
IDR300	Noise Isolation Headphones
HP6NC	Noise Cancelling Ear bud Headphones
IUHP6	HI-FI Ear Bud Headphones
IUHP6P	HI-FI Ear Bud Headphones (PINK)
HP1	Sport Ear bud Clip Headphones
IUHP3	Wrap Around Sport Ear Bud Headphones
IUHP2	Ear Bud Headphones
IUHP4	Retractable Ear Bud headphones

PROTECT



iPhone	
IP3GC	Clear polycarbonate case with Screen Protector
IP3GBK	Smoke polycarbonate case with Screen Protector
IP3GO	Orange polycarbonate case with Screen Protector
IP3GP	Pink polycarbonate case with Screen Protector
IP3GAB	Neoprene sport band case
IP3GS2	Clear Skin and Black Skin 2 pack
IP3GSCBK	Smoke Polycarbonate case & Black Skin (2 pack)



touch	
IT2C	Clear Polycarbonate case for 2nd Gen touch
IT2BK	Smoke Polycarbonate case for 2nd Gen touch
IT2S	Clear Skin for 2nd Gen touch
IT2S2	Clear & Black Skin (2 pack) for 2nd Gen touch
IT2SCBK	Smoke Polycarbonate case & Black Skin (2 pack) for 2nd Gen touch



4th Gen nano	
IN4C	Clear Polycarbonate case for 4th Gen nano
IN4BK	Smoke Polycarbonate case for 4th Gen nano
IN4S	Clear Skin for 4th Gen nano
INS4S2	Clear & Black Skin (2 pack) for 4th Gen nano
IN4SCBK	Smoke Polycarbonate case & clear skin (2 pack) for 4th Gen nano
IN4AB	Nano neoprene sport band case

Video & Classic 30/60/80/160GB	
ICC	Clear Polycarbonate Case for iPod Classic fits 80 & 160GB
IS2	Clear & Black Skin (2 pack) for 80GB iPod Classic

Screen Protectors	
FPP2	iPhone 3G Anti Glare Screen Protector 2 pack
FPT2	Anti Glare Screen Protector 2 pack for touch
FPN2	Screen Protector 2 pack for 4th Gen nano

Travel Case	
IPTRVL	iPod Travel case





ACCUMAT SOUND DAMPING



060" Foil backed Sound deadening - Door kit
HyperFlex Damping material for interior panels; trunks and doors.
4 pcs., 12 x 27, Box



Part Number

SCO-AMT06HFDK

060" Foil backed Sound deadening Car kit
HyperFlex Damping material for interior panels; trunks and doors.
Box of 8 (24 x 27" panels)



Part Number

SCO-AMT06HF

HyperFlex Speaker Kit
Damping material for interior panels; trunks and doors. 2 pcs., 12 x 12



Part Number

SCO-AMT06HFSK



Universal PAC Audio Controller for Various Vehicles

- Plug-and-play installation maintains factory wiring integrity
- Direct audio input to factory radio for maximum sound quality
- Two separate inputs - RCA and 3.5mm mini jack - for use a multitude of auxiliary audio sources
- Retains factory-installed satellite radio
- Integrates two auxiliary audio sources directly to the factory radio for the highest possible sound quality. Ideal for mp3 players, portable DVD players, handheld GPS, laptops and gaming systems.

Part Number	Description
PAC-GM11	Dual Auxiliary Audio Input Interface for Select General Motors Vehicles
PAC-GM11B	Dual Auxiliary Audio Input Interface for Select General Motors Vehicles
PAC-GM29	Dual Auxiliary Audio Input Interface for Select General Motors Vehicles
PAC-GMC2	Dual Auxiliary Audio Input Interface for Select General Motors Vehicles
PAC-HON1	Dual Auxiliary Audio Input Interface for Select Honda
PAC-HY1	Dual Auxiliary Audio Input Interface for Select Hyundai Vehicles
PAC-HY2	Dual Auxiliary Audio Input Interface for Select Hyundai Vehicles
PAC-NIS1	Dual Auxiliary Audio Input Interface for Select Nissan Infiniti Vehicles
PAC-NIS2	Dual Auxiliary Audio Input Interface for Select Nissan Infiniti Vehicles
PAC-ST5	Dual Auxiliary Audio Input Interface for the Cadillac STS
PAC-TOY1	Dual Auxiliary Audio Input Interface for Select Toyota Scion LEXUS Vehicles
PAC-VW2	Dual Auxiliary Audio Input Interface for Select Volkswagen Vehicles



85D south Hoffman Lane / Islandia, NY 11749

Phone: 1-800-634-2958 Fax: 1-631-348-1770



FILE UPDATE / CREDIT APPLICATION

Completed credit application is required to obtain terms, or for acceptance of company check for COD payment. Please complete and Fax or Mail for quick approval

Company Name	Telephone: _____
Owner Name	Fax No: _____
	Email: _____
	How long are you in business: _____
	Tax ID Number: _____
	Resale Certificate Number: _____

Mailing Address: _____
Shipping Address: _____

Names of Authorized Personal:

Purchasing Contact: _____
Accounts Payable Contact: _____
Other Contact: _____

Bank Information

Bank Name: _____ Account #: _____
Address: _____ City: _____ ST.: _____ Zip: _____
Telephone: _____ Fax No.: _____

Credit Card Information

Credit Card Number: _____ EXP: _____ Type: _____
Name On Credit card: _____

Credit References (Three)

Vendor Name: _____	Contact: _____
Address: _____	City: _____ ST.: _____ Zip: _____
Telephone: _____	Fax No.: _____
Vendor Name: _____	Contact: _____
Address: _____	City: _____ ST.: _____ Zip: _____
Telephone: _____	Fax No.: _____
Vendor Name: _____	Contact: _____
Address: _____	City: _____ ST.: _____ Zip: _____
Telephone: _____	Fax No.: _____

In the event that your company will be approved or is now an open account, please note that ALL PAST DUE invoices (balances over 30 Days) will be charged 1.5% per month or 18% per annum. **In the event the claim is sent to an agency, you will be responsible for collection costs. In the event of litigation, customer will be responsible for court costs and attorneys fees.**

The above-mentioned company is authorized to inquire on our credit history

Officers Signature: _____ Title: _____
Print Name: _____ Date: _____



QUOTE / ORDER FORM

Company Name: _____ Date: _____

Address: _____ Customer: _____

_____ Purchase #: _____

_____ Quote #: _____

Phone #: _____ Fax #: _____

Contact Person: _____ Email Address: _____

Ship Via (Circle One)

UPS Ground 3rd Day 2nd Day Next Day Other: _____

Quantity	Part Number	Unit Price	Total

MINIMUM ORDER IS \$50.00

FAX 1-631-348-1770
EMAIL SALES@HAINESENTERPRISES.COM

Business days in transit from: ISLANDIA, NY 11749

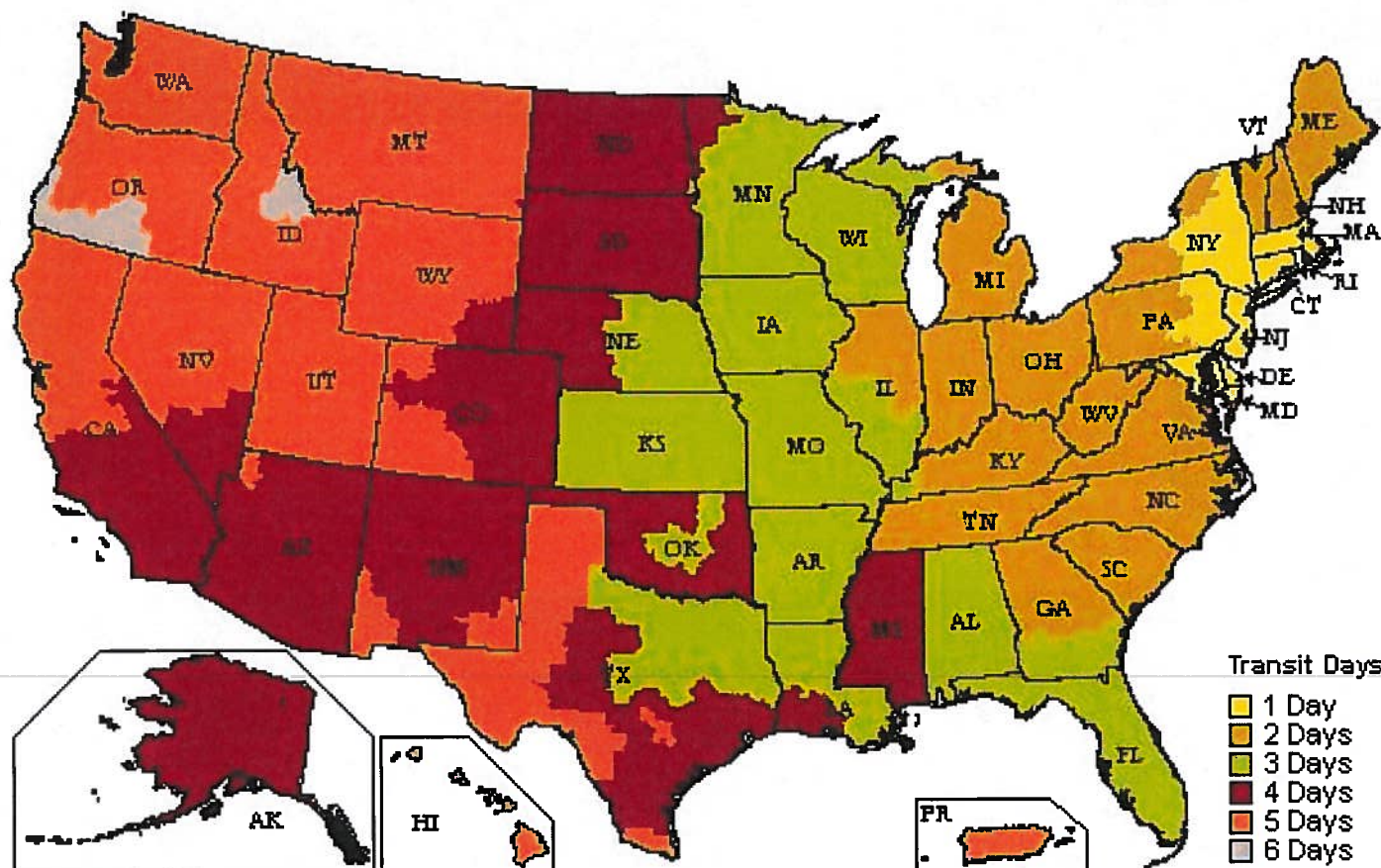

To Order Call:

Toll free: (800) 634-2958 Local: (631) 348-1750
or FAX (631) 348-1770

Email: Sales@Hainesenterprises.com
WWW.HAINESENTERPRISES.COM

Hours

Monday-Friday
9:00AM – 5:00 PM EST.

Haines Enterprises Inc.
85D South Hoffman Lane
Islandia, New York 11749

PRESORTED STD
U.S. POSTAGE
PAID
MAILED FROM
ZIP CODE 11722
PERMIT# 323

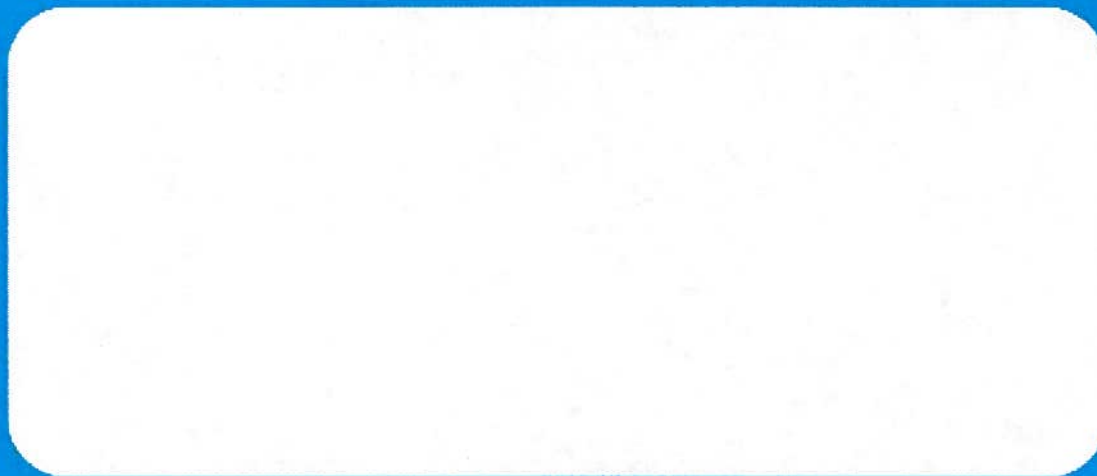

Haines Enterprises Inc.
85D South Hoffman Lane
Islandia, New York 11749

Toll Free: 800-634-2958

Local: 631-348-1750 - Fax: 631-348-1770

www.hainesmobile.com

www.hainesenterprises.com

EMAIL: info@hainesenterprises.com

**H
E
N
E
S**



**ENTERPRISES
INC.**